

Residential and Light Commercial Ductless Systems Catalog

July 2019





Table of Contents

Midea Global	3
Ductless Benefits	5
Single and Multi-Zone Solutions	9
Single Zone Residential	13
Max Series	15
Advantage Series	21
Standard Series	35
Multi-Zone	45
Single Zone Light Commercial	51
Accessories and Additional Information	63
Tiers, Warranties & Controls	70
Glossary	72



TO KNOW US IS TO TRUST US

Hello. We are Midea, the world's leading manufacturer of consumer appliances, HVAC systems, robotics and industrial automation systems.

Just getting to know us?
Midea is a publicly listed Fortune 500 company with over 130,000 employees, 21 production facilities worldwide, 12 strategic business units, and 260 logistics centers.

We are present in more than 200 countries, with a U.S. operation that is bringing user-friendly solutions to millions of consumers and businesses for over five years.

Those who know us trust our ongoing commitment to technological innovation and consumer-driven product development. We are forever focused on the constant improvement of our offerings and also providing the best service possible. The 40+ design awards we win annually from respected global design shows are further testament to our quest to develop unique products that are a joy to use.

Ductless systems, or “mini-splits,” are a convenient, economical and energy-efficient air conditioning and heating solution that can be used in one room or easily expanded to multiple rooms.

DUCTLESS MEANS WHAT IT SOUNDS LIKE, NO DUCTS NEEDED.

Installing or expanding an HVAC system might not always be the best solution for your changing heating and cooling needs. With a ductless system you only need to run small refrigerant linesets from an outdoor unit directly to the indoor unit in rooms you want to heat or cool. Installation is faster, requires less labor and is less disruptive to a home or business.

Ductless systems can also help you avoid costly energy loss by shortening the distance the air has to travel while at the same time giving you more control over the comfort level of your spaces. By setting up and controlling individual zones, homeowners can save money by only heating or cooling rooms that are occupied. With highly efficient Inverter systems and the condenser stationed outside, ductless systems are also a quiet solution.

Midea Ductless Systems can be an energy-saving solution for a variety of applications that help customers regain control of their space, including, but not limited to:

- New construction and renovations
- Homes and businesses
- Single or multi-family
- Primary living areas
- Rooms that are often too hot or too cold
- Basements, attics, garages, additions
- Server rooms

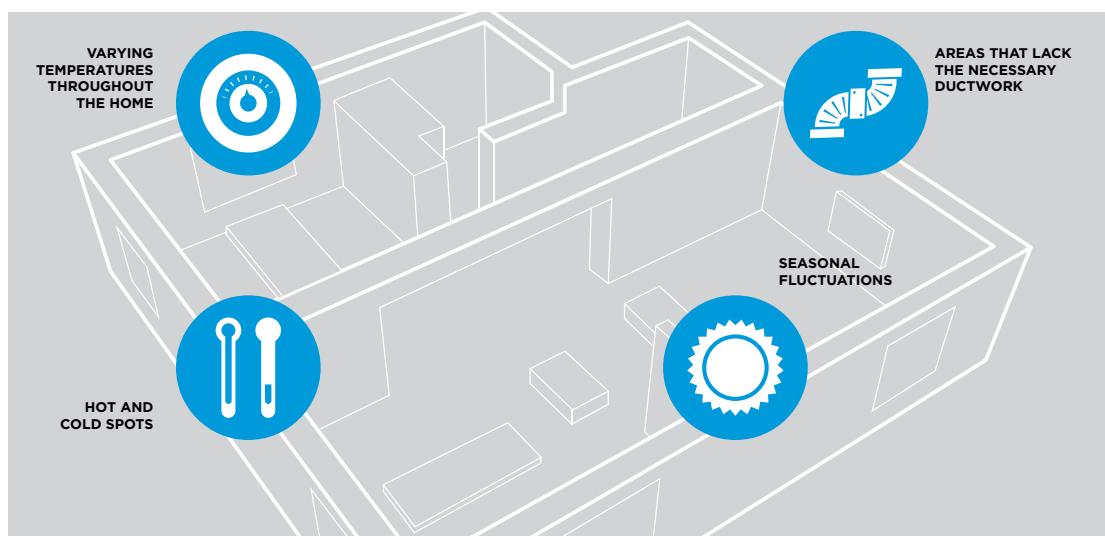



PERFORMANCE

Easy Installation and Use — A simple and intuitive remote allows users to easily control their unit(s). For installation, an innovative bracket holds the wall unit in place, allowing for easy connection to the refrigeration unit. And for multi-zone installs, there's no need for a branch box, which saves installation effort and costs.



Broad Temperature Range — Our models provide low temperature heating to a frigid -22° F, with up to 89% of rated capacity at -13° F, and cooling even when temperatures reach as high as 122° F.



EFFICIENCY

Low Energy Use — With SEER ratings of 40.0 on our highest tier offering, we have one of the highest efficiency ratings in the world.



ENERGY STAR® Certification — Full Inverter technology in the high tier and mid-tier series not only allows for quieter operation, but also delivers industry-leading efficiency. In fact, 70% of our Advantage Series models are ENERGY STAR® certified.



Washable Filters — Our filters are specifically manufactured for cleaner air quality and reduced allergens. The filtration systems also allow for easy cleaning and replacing.



INNOVATION

Inverter Technology — Unlike traditional compressors that turn on and off multiple times, Midea Inverter compressors feature variable power that automatically adjusts the running speed to maintain the desired temperature. That way, a Midea unit runs quietly and features significant energy savings.



Wi-Fi® Enablement — Easy connectivity with an intuitive app allows users to control and monitor our systems across all tiers, from a handheld device, anytime, anywhere.



Flexible Options — We offer several types of indoor unit styles to fit all customer needs and situations. And our versatile outdoor options allow users the ability to leverage just one outdoor unit across up to five indoor units at a time.



World's
No. 1 Air-
treatment
Company

Source: Euromonitor International Limited; Consumer Appliances 19ed, retail volume sales in units, 2018 data



MEETING THE FULL SPECTRUM OF HEATING & COOLING NEEDS

At Midea, it's our mission to help customers gain control of their space, whether it's a small residential room or a large commercial application.

That's why we offer a broad lineup of flexible and versatile ductless solutions that meet a wide range of needs—
from compact and efficient residential units to bigger and stronger light commercial products.

Most other manufacturers can't give you access to such a breadth of solutions.



Midea Ductless Systems provide an efficient, flexible and customizable heating and cooling solution for a single area of a home or business, or a multi-zone solution to individually manage several different zones using one integrated system of indoor and outdoor units.

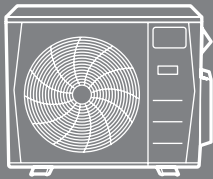

Single zone systems provide comfort for areas with as little as 350 and as much as 3,000 square feet — either small offices or bedrooms, or big living and cooking areas.

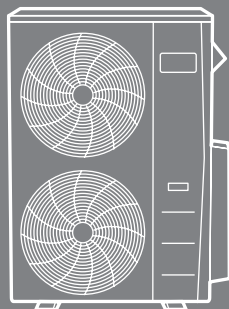



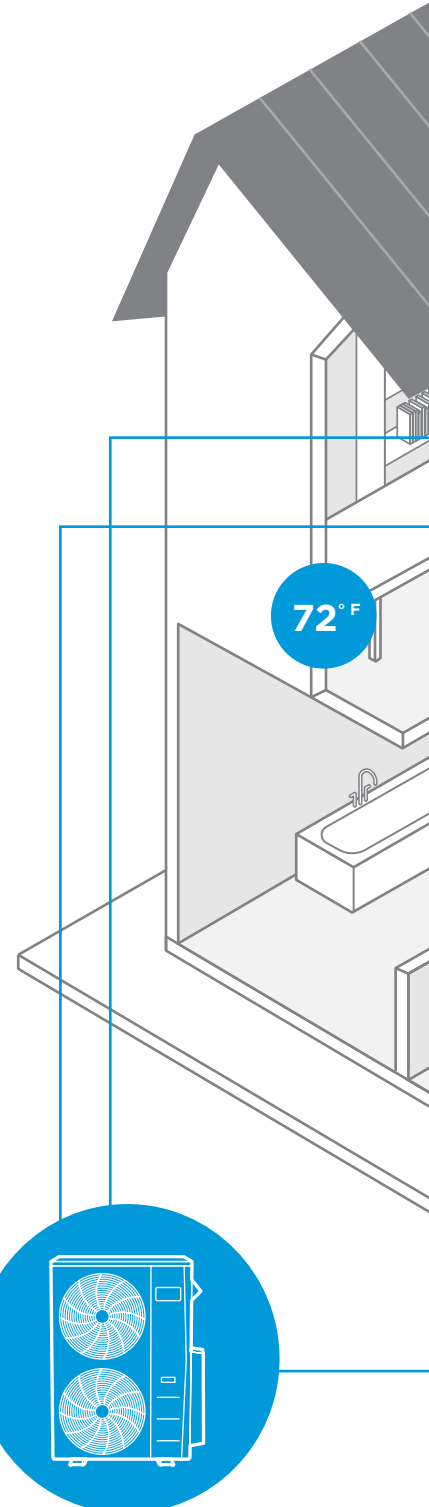

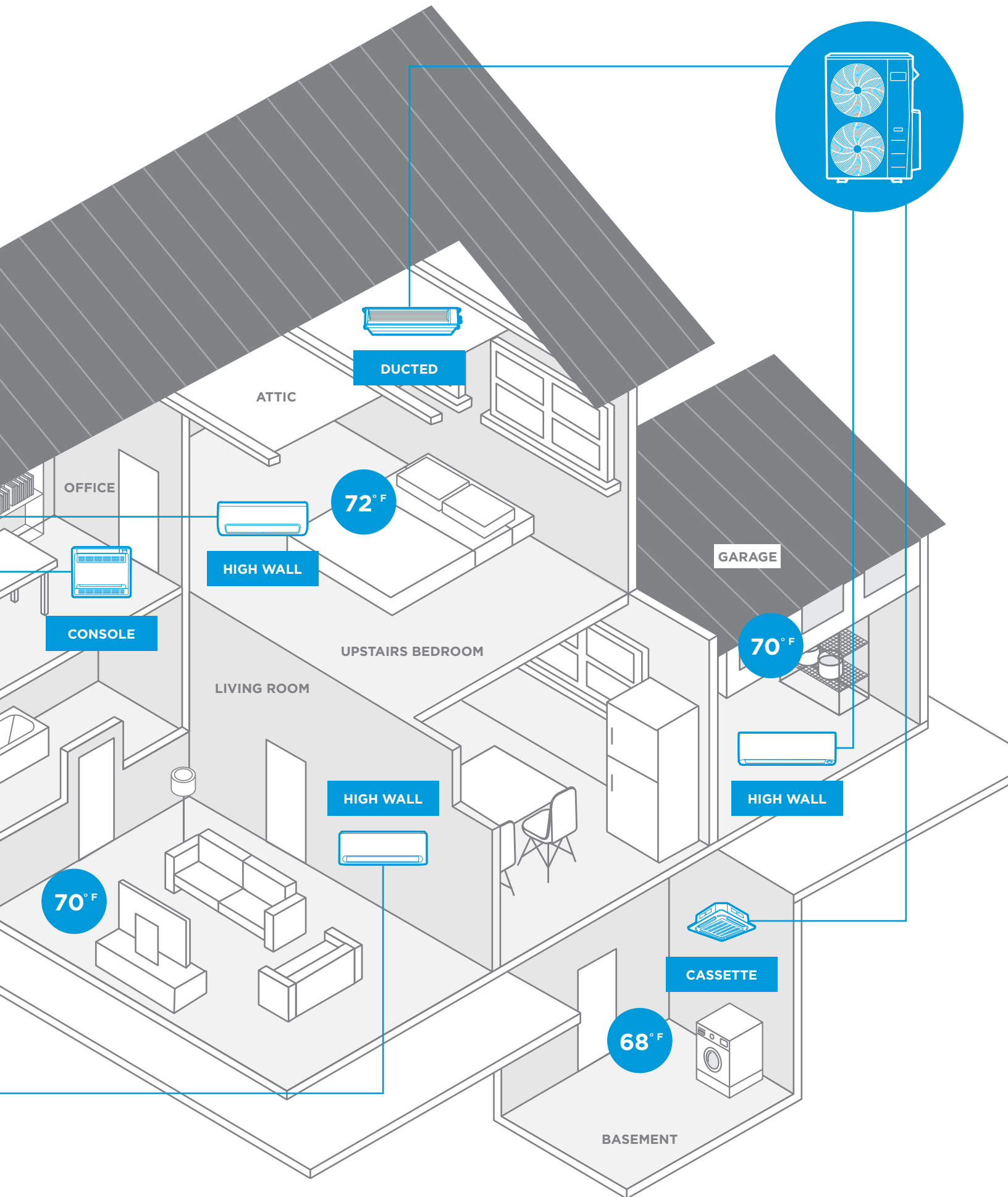



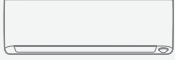
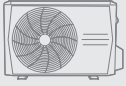



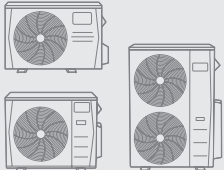

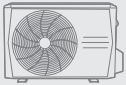



Multi-zone systems can connect as many as five indoor units with a single outdoor unit — with comfort all around the house or application, using individual controls for zoning and energy savings.

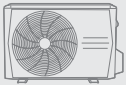

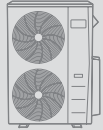
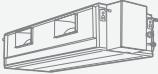

The Right Product for the Right Application

	SINGLE ZONE RESIDENTIAL		MULTI-ZONE	
	Indoor Units	Outdoor Units	Indoor Units	Outdoor Units
MAX SERIES	 DLFPHA High Wall Sizes: 09 / 12	 DLCPPRA Outdoor Unit Up to 40.0 SEER Sizes: 09 / 12 / 18 / 24	 DLFPHA High Wall Sizes: 09 / 12	
	 DLFPHA High Wall Sizes: 18 / 24			
ADVANTAGE SERIES	 DLFSHA High Wall Sizes: 09 / 12 / 18 / 24 / 30 / 36		 DLFSHA High Wall Sizes: 09 / 12 / 18 / 24 / 30 / 36	
	 DLFSCA Cassette Sizes: 09 / 12 / 18 / 24	 DLCSSRA Outdoor Unit Up to 24.7 SEER Sizes: 09 / 12 / 18 / 24 / 30 / 36	 DLFSCA Cassette Sizes: 09 / 12 / 18 / 24	DLCMRA Outdoor Unit Up to 21.4 SEER Sizes: 18 / 27 / 36 / 48
	 DLFSDA Ducted Sizes: 09 / 12 / 18 / 24		 DLFSDA Ducted Sizes: 09 / 12 / 18 / 24	
	 DLFSFA Console Sizes: 12 / 18 / 24		 DLFSFA Console Sizes: 12 / 18 / 24	
STANDARD SERIES	 DLFEHA High Wall Sizes: 09 / 12 / 18 / 24	 DLCERA Outdoor Unit Up to 17.6 SEER Sizes: 09 / 12 / 18 / 24	 DLFEHA High Wall Sizes: 09 / 12 / 18 / 24	

SINGLE ZONE LIGHT COMMERCIAL	
Indoor Units	Outdoor Units
 DLFLCA Cassette Sizes: 36 / 48	  DLCLRA Outdoor Unit Up to 18.0 SEER Sizes: 36 / 48 / 58
 DLFLDA Ducted Sizes: 36 / 48 / 58	
 DLFLFA Console Sizes: 36 / 48 / 58	

SYSTEM	SIZES	SEER	HSPF	Page
SINGLE ZONE RESIDENTIAL				
DLCPRA Outdoor Unit	Sizes: 09 / 12 / 18 / 24	Up to 40.0 SEER	Up to 14.5 HSPF	15-16
DLFPHA High Wall	Sizes: 09 / 12			17-18
DLFPHA High Wall	Sizes: 18 / 24			19-20
SINGLE ZONE RESIDENTIAL				
DLCSRA Outdoor Unit	Sizes: 09 / 12 / 18 / 24 / 30 / 36	Up to 24.7 SEER	Up to 11.0 HSPF	21-24
DLFSHA High Wall	Sizes: 09 / 12 / 18 / 24 / 30 / 36			25-26
DLFSCA Cassette	Sizes: 09 / 12 / 18 / 24			27-28
DLFSDA Ducted	Sizes: 09 / 12 / 18 / 24			29-30
DLFSFA Console	Sizes: 12 / 18 / 24			31-32
SINGLE ZONE RESIDENTIAL				
DLCERA Outdoor Unit	Sizes: 09 / 12 / 18 / 24	Up to 17.6 SEER	10.6 HSPF	35-38
DLFEHA High Wall	Sizes: 09 / 12 / 18 / 24			39-42
MULTI-ZONE				
DLCMRA Outdoor Unit	Sizes: 18 / 24 / 30 / 36 / 48	Up to 21.4 SEER	Up to 10.8 HSPF	47-50
SINGLE ZONE LIGHT COMMERCIAL				
DLCLRA Outdoor Unit	Sizes: 36 / 48 / 58	Up to 18.0 SEER	Up to 11.5 HSPF	53-56
DLFLCA Cassette	Sizes: 36 / 48			57-58
DLFLDA Ducted	Sizes: 36 / 48 / 58			59-60
DLFLFA Console	Sizes: 36 / 48 / 58			61-62

SINGLE ZONE RESIDENTIAL



DLCPRA Outdoor Unit
Up to 40.0 SEER
Sizes: 09 / 12 / 18 / 24



DLFPH High Wall
Sizes: 09 / 12



DLFPH High Wall
Sizes: 18 / 24



DLCSRA Outdoor Unit
Up to 24.7 SEER
Sizes: 09 / 12 / 18 / 24 / 30 / 36



DLFSHA High Wall
Sizes: 09 / 12 / 18 / 24 / 30 / 36



DLFSCA Cassette
Sizes: 09 / 12 / 18 / 24



DLFSDA Ducted
Sizes: 09 / 12 / 18 / 24



DLFSFA Console
Sizes: 12 / 18 / 24



DLCERA Outdoor Unit
Up to 17.6 SEER
Sizes: 09 / 12 / 18 / 24



DLFEHA High Wall
Up to 17.6 SEER



A Versatile Outdoor Unit for Precise Temperature Control

OUTDOOR FEATURES

- 100% Heating capacity at 0° F (-17° C)
- 100% Cooling capacity at -22° F (-30° C) without additional kit
- Up to 75% of Heating capacity at -22° F (-30° C)
- Available in 208/230V
- Built-in basepan heater
- Auto-restart function
- Refrigerant leakage detection
- Quiet outdoor operation, as low as 55 dB(A)
- Aluminum Golden Hydrophilic pre-coated fins
- Piping length 98 ft. (30 m.)
- Cooling operating range -22° ~ 122° F (-30° ~ 50° C)
- Heating operating range -22° ~ 86° F (-25° ~ 30° C)

COMPATIBLE WITH:

- DLFPHA High Wall (p 17)

Heat Pump with Basepan Heater

Inverter Compressor

Up to 40.0 SEER

Up to 14.5 HSPF

Sizes: 09 / 12 / 18 / 24

All systems are ENERGY STAR® certified



KEY FEATURES

Extra Low Temperature Heating

Heat output up to 75% of rated capacity down to -22° F (-30° C), so when its cold outside, it will be warm inside making this a primary heat source, and reducing the need for a backup heat source.

Stepless Frequency Adjustment

Precise control maintains stable and constant room temperature while reducing sound level and energy consumption.

COMPATIBILITY:

Indoor Unit		Outdoor Unit			
		DLCPRAH09AAK	DLCPRAH12AAK	DLCPRAH18AAK	DLCPRAH24AAK
High Wall	DLFPHAH09XAK	•			
	DLFPHAH12XAK		•		
	DLFPHAH18XAK			•	
	DLFPHAH24XAK				•

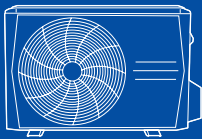

SPECIFICATIONS:

DLCPRA Outdoor Unit					
Heat Pump					
System					
Size		9	12	18	24
Outdoor Model		DLCPRAH09AAK	DLCPRAH12AAK	DLCPRAH18AAK	DLCPRAH24AAK
Electrical					
Voltage-Phase-Cycle	V-Ph-Hz	208/230-1-60	208/230-1-60	208/230-1-60	208/230-1-60
MCA	A.	13	15	18	20
MOCP - Fuse Rating	A.	15	20	30	30
Operating Range					
Cooling Outdoor DB Min - Max	° F (° C)	-22~122 (-30~50)	-22~122 (-30~50)	-22~122 (-30~50)	-22~122 (-30~50)
Heating Outdoor DB Min - Max	° F (° C)	-22~86 (-30~30)	-22~86 (-30~30)	-22~86 (-30~30)	-22~86 (-30~30)
Piping					
Total Piping Length	ft (m)	98 (30)	98 (30)	98 (30)	98 (30)
Piping Lift*	ft (m)	49 (15)	49 (15)	65 (20)	65 (20)
Pipe Connection Size - Liquid	in (mm)	1/4 (6.35)	1/4 (6.35)	3/8" (9.52)	3/8" (9.52)
Pipe Connection Size - Suction	in (mm)	3/8 (9.52)	1/2 (12.7)	5/8" (15.9)	5/8" (15.9)
Refrigerant					
Type		R410A	R410A	R410A	R410A
Charge	lbs (kg)	3.5 (1.58)	3.5 (1.58)	5.7 (2.6)	6.5 (2.95)
Outdoor					
Unit Width	in (mm)	33.27 (845)	33.27 (845)	37.24 (946)	37.24 (946)
Unit Height	in (mm)	27.64 (702)	27.64 (702)	31.89 (810)	31.89 (810)
Unit Depth	in (mm)	14.29 (363)	14.29 (363)	16.14 (410)	16.14 (410)
Net Weight	lbs (kg)	107.59 (48.8)	108.47 (49.2)	135.4 (61.4)	145.1(65.8)
Airflow	CFM	1,380	1,380	2,236	2,236
Sound Pressure	dB(A)	55.5	56.0	61.5	62.0

*Condensing unit above or below indoor unit.

PERFORMANCE:

High Wall					
Indoor Model		DLFPHAH09XAK	DLFPHAH12XAK	DLFPHAH18XAK	DLFPHAH24XAK
ENERGY STAR®		YES	YES	YES	YES
Cooling System Tons		0.8	1.0	1.5	1.8
Cooling Rated Capacity	Btu/h	9,000	12,000	18,000	22,000
Cooling Cap. Range Min - Max	Btu/h	5,000~17,000	5,800~19,000	6,888~30,511	7,445~32,644
SEER		40.0	30.0	28.2	23.5
EER		15	13.5	14.5	13.65
Heating Rated Capacity (47° F)	Btu/h	10,000	12,000	18,000	24,000
Heating Rated Capacity (17° F)	Btu/h	7,200	6,800	12,300	15,450
Heating Maximum Capacity (17° F)	Btu/h	15,690	17,070	22,000	22,000
Heating Maximum Capacity (5° F)	Btu/h	13,000	13,800	18,000	24,000
Heating Cap. Range Min - Max	Btu/h	3,100~19,000	3,500~21,000	10,835~29,414	12,050~32,270
HSPF		14.5	13.6	14.0	12.0
COP (47° F)	W/W	4.00	4.24	4.12	3.89
COP (17° F)	W/W	2.78	2.64	3.20	3.00
COP (5° F)	W/W	2.00	2.00	2.00	2.00



Superior Comfort from a Single Energy Efficient Unit

INDOOR FEATURES

- Available in 208/230V
- Relative Humidity Sensor
- Occupancy Sensor
- Modes: Cool, Heat, Dry, Fan, Auto
- Turbo Mode
- Fully modulating fan speeds
- Sleep Mode
- Up-down / right-left louver control (fixed or swing)
- ECO Mode
- Carbon filter
- Follow Me (senses temperature at handheld remote)
- Heating Setback (46° F Heating Mode)
- Quiet indoor operation, as low as 29 dB(A)
- Aluminum Golden Hydrophilic pre-coated fins
- Up to 40.0 SEER and 14.5 HSPF when paired with DLCPRA outdoor unit

COMPATIBLE WITH:

- DLCPRA Outdoor Unit Single Zone (p 15)
- DLCMRA Outdoor Unit Multi-Zone (p 47)

Sizes: 09 / 12

All systems are ENERGY STAR® certified based on outdoor unit pairing



KEY FEATURES

Relative Humidity Sensor

Increase comfort by setting the desired relative humidity in 5% increments in a range of 35% ~ 85%.

Occupancy Sensor

Detects activity in the room and adjusts the horizontal angle of airflow to blow away from people or follow people.

Wi-Fi®

Wi-Fi® connectivity is available (see below.)

CONTROLS

Wireless Remote Controller included with indoor unit
Optional Wired Remote Controller KSACN0401AAA (7-Day Programmable)

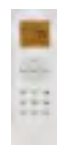

Wireless Remote Controller



Wired Controller (7-Day Programmable) KSACN0401AAA

ACCESSORIES

Wi-Fi® Kit KSAIF0601AAA



24V Interface for third-party thermostat compatibility KSAIC0401230



SPECIFICATIONS:

DLFPHA High Wall			
Heat Pump			
System			
Size		9	12
Indoor Model		DLFPHAH09XAK	DLFPHAH12XAK
Electrical			
Voltage-Phase-Cycle	V-Ph-Hz	208/230-1-60	208/230-1-60
Power Supply		Indoor unit powered from outdoor unit	
MCA	A.	0.3	0.3
Operating Range			
Cooling Indoor DB Min - Max	° F (° C)	62~90 (17~32)	62~90 (17~32)
Heating Indoor DB Min - Max	° F (° C)	32~86 (0~30)	32~86 (0~30)
Piping			
Pipe Connection Size - Liquid	in (mm)	1/4 (6.35)	1/4 (6.35)
Pipe Connection Size - Suction	in (mm)	3/8 (9.52)	1/2 (12.7)
Indoor			
Unit Width	in (mm)	35.2 (895)	35.2 (895)
Unit Height	in (mm)	11.7 (298)	11.7 (298)
Unit Depth	in (mm)	9.8 (248)	9.8 (248)
Net Weight	lbs (kg)	37.48 (17)	37.48 (17)
Number of Fan Speeds		4	4
Airflow (lowest to highest)	CFM	144/245/295/345	168/252/306/357
Sound Pressure (lowest to highest)	dB(A)	29/35.5/41.5/45.6	29/35.5/41.5/46.8
Air Throw Data	ft (m)	21.98 (6.7)	22.97 (7)
Moisture Removal	Pint/h (L/h)	2.11 (1.0)	2.53 (1.2)
Field Drain Pipe Size O.D.	in (mm)	1 (25.4)	1 (25.4)

COMPATIBILITY:

Indoor Unit	DLFPHAH09XAK	DLFPHAH12XAK
Outdoor Unit Single Zone*	DLCPPRAH09AAK	DLCPPRAH12AAK
Outdoor Unit Multi-Zone*	DLCMRAH18BAK DLCMRAH27CAK DLCMRAH36DAK DLCMRAH48EAK	

*Performance may vary based on the compatible outdoor units. See respective pages for performance data.



High Efficiency & Performance for Large Spaces

INDOOR FEATURES

- Available in 208/230V
- Modes: Cool, Heat, Dry, Fan, Auto
- Turbo Mode
- Fully modulating fan speeds
- Sleep Mode
- Up-down / Right-Left louver control (fixed or swing)
- Relative Humidity Sensor
- ECO Mode
- Carbon filter
- Follow Me (senses temperature at handheld remote)
- Heating Setback (46° F Heating Mode)
- Quiet indoor operation,
- Aluminum Golden Hydrophilic pre-coated fins

COMPATIBLE WITH:

- DLCpra Outdoor Unit Single Zone (p 15)

Sizes: 18 / 24

ENERGY STAR® certified based on outdoor unit pairing



KEY FEATURES

Large Residential Applications

A solution for large residential applications where more airflow or load is necessary, such as basements, garages, large living rooms, or even used as a centralized system.

Light Commercial Applications

With excellent performance and capacity these units can be installed in larger load applications like Restaurants, Offices, Data Closets / IT rooms.

Wi-Fi®

Wi-Fi® connectivity is available (see below.)

CONTROLS

Wireless Remote Controller included with indoor unit

Optional Wired Remote Controller KSACN0401AAA (7-Day programmable)

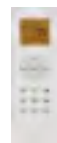

Wireless Remote Controller



Wired Controller (7-Day Programmable) KSACN0401AAA

ACCESSORIES

Wi-Fi® Kit KSAIF0601AAA



24V Interface for third-party thermostat compatibility KSAIC0401230



SPECIFICATIONS:

DLFPHA High Wall			
Heat Pump			
System			
Size		18	24
Indoor Model		DLFPHAH18XAK	DLFPHAH24XAK
Electrical			
Voltage-Phase-Cycle	V-Ph-Hz	208/230-1-60	208/230-1-60
Power Supply		Indoor unit powered from outdoor unit	
MCA	A.	0.5	0.5
Operating Range			
Cooling Indoor DB Min - Max	° F (° C)	62~90 (17~32)	62~90 (17~32)
Heating Indoor DB Min - Max	° F (° C)	32~86 (0~30)	32~86 (0~30)
Piping			
Pipe Connection Size - Liquid	in (mm)	3/8" (9.52)	3/8" (9.52)
Pipe Connection Size - Suction	in (mm)	5/8" (15.9)	5/8" (15.9)
Indoor			
Unit Width	in (mm)	49.57 (1259)	49.57(1259)
Unit Height	in (mm)	14.25 (362)	14.25 (362)
Unit Depth	in (mm)	11.10 (282)	11.10 (282)
Net Weight	lbs (kg)	43.4(19.7)	43.4 (19.7)
Number of Fan Speeds		4	4
Airflow (lowest to highest)	CFM	261/389/528/926	359/470/583/926
Sound Pressure (lowest to highest)	dB(A)	35.1/40.8/46.1/55.9	36.1/43.3/46.4/56.5
Air Throw Data	ft (m)	28.80 (8.7)	31.66 (9.65)
Moisture removal	Pint/h (L/h)	3.8 (1.8)	5.0 (2.39)
Field Drain Pipe Size O.D.	in (mm)	1 (25.4)	1 (25.4)

COMPATIBILITY:

Indoor Unit	DLFPHAH18XAK	DLFPHAH24XAK
Outdoor Unit Single Zone*	DLCPPAH18AAK	DLCPPAH24AAK

*Performance may vary based on the compatible outdoor units. See respective pages for performance data.

Note: Indoor units sizes 18-24 not compatible with Multi-Zone due to the size of the indoor unit coil.



A Versatile Outdoor Unit for Maximum Efficiency

OUTDOOR FEATURES

- 100% Heating capacity at 5° F (-15° C) sizes 12-18 (208/230V)
- Available in 115V and 208/230V
- Built-in basepan heater
- Auto-restart function
- Condenser high-temperature protection
- Refrigerant leakage detection
- Quiet outdoor operation, as low as 54.6 dB(A)
- Aluminum Golden Hydrophilic pre-coated fins
- Piping length 82 ~ 164 ft. (25 ~ 50 m.)
- Cooling operating range -13° ~ 122° F (-25° ~ 50° C)
- Heating operating range -22° ~ 86° F (-30° ~ 30° C)
 Sizes 09-24 (208/230V)
 -13° ~ 86° F (-25° ~ 30° C)
 Sizes 09, 12 (115V) & 30, 36 (208/230V)

COMPATIBLE WITH:

- DLFSHA High Wall (p 25)
- DLFSCA Cassette (p 27)
- DLFSDA Ducted (p 29)
- DLFSFA Console (p 31)

Heat Pump with Basepan Heater

Inverter Compressor

Up to 24.7 SEER

Up to 11.0 HSPF

Sizes: 09 / 12 / 18 / 24 / 30 / 36

Select sizes are ENERGY STAR® certified based on outdoor unit pairing



KEY FEATURES

Extra Low Temperature Heating

When it's cold outside, the heat output for this system is up to 69% of rated capacity down to -22° F (-30° C), making this a primary heat source and eliminating the need for a backup heat source.

Stepless Frequency Adjustment

Precise control of the system maintains a stable and constant room temperature while reducing sound level and saving energy.

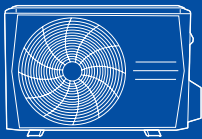

PERFORMANCE:

DLFSHA High Wall								
Indoor Model		DLFSAH12XAJ	DLFSAH09XAK	DLFSAH12XAK	DLFSAH18XAK	DLFSAH24XAK	DLFSAH30XAK	DLFSAH36XAK
ENERGY STAR®		YES	YES	YES	YES	YES	YES	NO
Cooling System Tons		1.0	0.75	1.0	1.5	2.0	2.5	3.0
Cooling Rated Capacity	Btu/h	12,000	9,000	12,000	18,000	24,000	30,000	36,000
Cooling Cap. Range Min - Max	Btu/h	3,500~12,200	3,500~12,600	4,200~12,900	4,300~21,200	5,200~23,000	8,000~32,500	8,000~37,800
SEER		20.4	24.7	21.5	22.0	20.0	20.0	18.0
EER		12.5	14.0	12.5	12.5	12.5	12.5	10.5
Heating Rated Capacity (47° F)	Btu/h	11,800	12,000	12,000	18,000	25,000	30,000	36,000
Heating Rated Capacity (17° F)	Btu/h	7,200	7,500	7,600	11,900	15,000	18,000	21,000
Heating Maximum Capacity (17° F)	Btu/h	8,000	12,400	12,800	21,500	22,700	25,300	29,700
Heating Maximum Capacity (5° F)	Btu/h	7,800	10,700	12,100	20,700	23,300	19,500	23,400
Heating Cap. Range Min - Max	Btu/h	1,300~12,400	1,300~14,500	1,400~13,900	2,900~22,900	2,300~26,800	2,600~30,400	2,700~36,000
HSPF		11.0	10.5	11.0	10.5	10.0	9.8	10.0
COP (47° F)	W/W	3.20	3.17	3.20	3.22	2.93	3.52	3.44
COP (17° F)	W/W	2.60	2.65	2.40	2.50	2.35	2.55	2.60
COP (5° F)	W/W	1.97	1.60	1.60	1.60	1.70	1.64	1.50

PERFORMANCE:

DLFSCA Cassette					
Indoor Model		DLFSCAH09XAK	DLFSCAH12XAK	DLFSCAH18XAK	DLFSCAH24XAK
ENERGY STAR®		YES	YES	YES	NO
Cooling System Tons		0.75	1.0	1.4	2.0
Cooling Rated Capacity	Btu/h	9,000	12,000	16,000	24,000
Cooling Cap. Range Min - Max	Btu/h	3,000~13,000	3,300~12,000	6,000~18,700	11,000~28,600
SEER		20.0	19.5	20.0	20.0
EER		13.0	12.5	12.5	11.0
Heating Rated Capacity (47° F)	Btu/h	10,000	12,000	18,000	24,000
Heating Rated Capacity (17° F)	Btu/h	6,700	8,200	12,000	16,200
Heating Maximum Capacity (17° F)	Btu/h	14,300	14,700	22,700	31,700
Heating Maximum Capacity (5° F)	Btu/h	12,200	12,300	20,000	30,000
Heating Cap. Range Min - Max	Btu/h	4,000~15,200	3,300~15,000	8,900~21,400	10,200~33,600
HSPF		10.2	10.2	10.5	11.5
COP (47° F)	W/W	3.37	3.55	2.95	3.66
COP (17° F)	W/W	2.57	2.43	2.58	2.97
COP (5° F)	W/W	1.71	1.70	1.45	1.93

PERFORMANCE:

DLFSDA Ducted					
Indoor Model		DLFSDAH09XAK	DLFSDAH12XAK	DLFSDAH18XAK	DLFSDAH24XAK
ENERGY STAR®		YES	YES	YES	YES
Cooling System Tons		0.75	1.0	1.4	2.0
Cooling Rated Capacity	Btu/h	9,000	12,000	16,500	24,000
Cooling Cap. Range Min - Max	Btu/h	3,000~13,000	3,300~12,000	6,000~18,700	11,000~28,700
SEER		22.5	20.5	20.0	21.0
EER		14.0	12.5	12.5	12.5
Heating Rated Capacity (47° F)	Btu/h	10,000	12,500	19,000	24,000
Heating Rated Capacity (17° F)	Btu/h	6,800	8,100	12,400	17,400
Heating Maximum Capacity (17° F)	Btu/h	14,300	14,700	22,700	31,700
Heating Maximum Capacity (5° F)	Btu/h	12,200	12,300	20,000	30,000
Heating Cap. Range Min - Max	Btu/h	4,000~15,200	3,300~15,000	8,900~21,400	10,200~33,600
HSPF		11.5	11.0	10.8	12.0
COP (47° F)	W/W	3.37	3.55	2.95	3.66
COP (17° F)	W/W	2.57	2.43	2.58	2.97
COP (5° F)	W/W	1.71	1.70	1.45	1.93

PERFORMANCE:

DLFSFA Console				
Indoor Model		DLFSFAH12XAK	DLFSFAH18XAK	DLFSFAH24XAK
ENERGY STAR®		YES	YES	NO
Cooling System Tons		1.0	1.4	2.0
Cooling Rated Capacity	Btu/h	12,000	17,000	24,000
Cooling Cap. Range Min - Max	Btu/h	4,200~13,100	6,600~20,600	11,000~29,200
SEER		19.4	19.9	20.0
EER		12.5	12.5	11.5
Heating Rated Capacity (47° F)	Btu/h	12,000	18,000	24,000
Heating Rated Capacity (17° F)	Btu/h	9,600	12,900	17,200
Heating Maximum Capacity (17° F)	Btu/h	13,500	21,500	27,950
Heating Maximum Capacity (5° F)	Btu/h	12,300	18,700	25,000
Heating Cap. Range Min - Max	Btu/h	4,800~13,600	9,000~22,300	10,200~18,400
HSPF		10.5	10.2	11.5
COP (47° F)	W/W	3.43	3.48	3.66
COP (17° F)	W/W	2.66	2.30	2.80
COP (5° F)	W/W	1.62	1.60	1.67

Manufacturer reserves the right to discontinue, or change at any time, specification or designs without notice or incurring obligations.

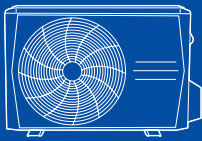

SPECIFICATIONS:

DLCSRA Outdoor Unit								
Heat Pump								
System								
Size		12	9	12	18	24	30	36
Outdoor Model		DLCSRAH12AAJ	DLCSRAH09AAK	DLCSRAH12AAK	DLCSRAH18AAK	DLCSRAH24AAK	DLCSRAH30AAK	DLCSRAH36AAK
Electrical								
Voltage-Phase-Cycle	V-Ph-Hz	115-1-60	208/230-1-60	208/230-1-60	208/230-1-60	208/230-1-60	208/230-1-60	208/230-1-60
MCA	A.	15	9	9	17	20	20	25
MOCP	A.	20	15	15	25	30	30	35
Operating Range								
Cooling Outdoor DB Min - Max	° F (° C)	-13~122 (-25~50)	-13~122 (-25~50)	-13~122 (-25~50)	-13~122 (-25~50)	-13~122 (-25~50)	-13~122 (-25~50)	-13~122 (-25~50)
Heating Outdoor DB Min - Max	° F (° C)	-13~86 (-25~30)	-22~86 (-30~30)	-22~86 (-30~30)	-22~86 (-30~30)	-22~86 (-30~30)	-13~86 (-25~30)	-13~86 (-25~30)
Piping								
Total Piping Length	in (mm)	82 (25)	82 (25)	82 (25)	98 (30)	98 (30)	164 (50)	164 (50)
Piping Lift*	in (mm)	32 (10)	32 (10)	32 (10)	66 (20)	66 (20)	82 (25)	82 (25)
Pipe Connection Size - Liquid	in (mm)	1/4 (6.35)	1/4 (6.35)	1/4 (6.35)	1/4 (6.35)	3/8 (9.52)	3/8 (9.52)	3/8 (9.52)
Pipe Connection Size - Suction	in (mm)	1/2 (12.7)	3/8 (9.52)	1/2 (12.7)	1/2 (12.7)	5/8 (16)	5/8 (16)	5/8 (16)
Refrigerant								
Type	in (mm)	R410A	R410A	R410A	R410A	R410A	R410A	R410A
Charge	lbs (kg)	2.64 (1.15)	3.31 (1.5)	3.31 (1.5)	4.3 (1.95)	5.73 (2.6)	6.06 (2.75)	7.49 (3.4)
Outdoor								
Unit Width	in (mm)	31.5 (800)	31.5 (800)	31.5 (800)	33.27 (845)	37.24 (946)	37.24 (946)	37.24 (946)
Unit Height	in (mm)	21.81 (554)	21.81 (554)	21.81 (554)	27.63 (702)	31.89 (810)	31.89 (810)	31.89 (810)
Unit Depth	in (mm)	13.11 (333)	13.11 (333)	13.11 (333)	14.26 (363)	16.54 (420)	16.54 (420)	16.54 (420)
Net Weight	lbs (kg)	80.7 (36.6)	90.8 (41.2)	91.7 (41.6)	113.3 (51.4)	141.1 (64)	137.8 (62.5)	143.3 (65)
Airflow	CFM	1,177	1,177	1,177	1,824	2,355	2,119	2,119
Sound Pressure	dB(A)	54.7	56.6	54.6	58.9	61.0	60.0	60.0

*Condensing unit above or below indoor unit.

COMPATIBILITY:

Indoor Unit	DLCSRA Outdoor Unit						
	DLCSRAH12AAJ	DLCSRAH09AAK	DLCSRAH12AAK	DLCSRAH18AAK	DLCSRAH24AAK	DLCSRAH30AAK	DLCSRAH36AAK
DLFSHA High Wall	DLFSAH12XAJ	DLFSAH09XAK	DLFSAH12XAK	DLFSAH18XAK	DLFSAH24XAK	DLFSAH30XAK	DLFSAH36XAK
DLFSCA Cassette*		DLFSCAH09XAK	DLFSCAH12XAK	DLFSCAH18XAK	DLFSCAH24XAK		
DLFSDA Ducted*		DLFSDAH09XAK	DLFSDAH12XAK	DLFSDAH18XAK	DLFSDAH24XAK		
DLFSFA Console*			DLFSFAH12XAK	DLFSFAH18XAK	DLFSFAH24XAK		

*Cassette, Ducted and Console indoor units sizes 36, 48 & 58 ONLY compatible with DLCLRA Outdoor Unit.



Built-In Temperature Control for Ultimate Energy Savings

INDOOR FEATURES

- Available in 115V and 208/230V
- Up to 24.7 SEER and 11.0 HSPF when paired with the DLCSRA outdoor unit
- Modes: Cool, Heat, Dry, Fan, Auto
- Turbo Mode
- Four fan speeds
- Sleep Mode
- ECO Mode
- Up-down louver control (fixed or swing)
- Follow Me (senses temperature at handheld remote)
- Heating Setback (46° F Heating Mode)
- Quiet indoor operation, as low as 25 dB(A)
- Aluminum Golden Hydrophilic pre-coated fins

COMPATIBLE WITH:

- DLCSRA Outdoor Unit Single Zone (p 21)
- DLCMRA Outdoor Unit Multi-Zone (p 47)

Sizes: 09 / 12 / 18 / 24 / 30 / 36

Select sizes are ENERGY STAR® certified based on outdoor unit pairing



KEY FEATURES

ECO Mode

The intelligent 8-hour night cycle program saves up to 60% of energy to make it more comfortable at night while sleeping.

Follow Me

Built-in temperature sensor in the Remote Controller will sense its surrounding temperature and adjust the room temperature more accurately to provide greater comfort.

CONTROLS

Wireless Remote Controller included with indoor unit

Optional Wired Remote Controller KSACN0101AAA (Timer Function)

Optional Wired Remote Controller KSACN0401AAA (7-Day Programmable)



Wireless Remote Controller



Wired Controller (Timer Function) KSACN0101AAA

ACCESSORIES



Wi-Fi® Kit KSAIF0501AAA

24V Interface for third-party thermostat compatibility KSAIC0401230



SPECIFICATIONS:

DLF SHA High Wall								
Heat Pump								
System								
Size		12	9	12	18	24	30	36
Indoor Model		DLF SHAH12XAJ	DLF SHAH09XAK	DLF SHAH12XAK	DLF SHAH18XAK	DLF SHAH24XAK	DLF SHAH30XAK	DLF SHAH36XAK
Electrical								
Voltage-Phase-Cycle	V-Ph-Hz	115-1-60	208/230-1-60	208/230-1-60	208/230-1-60	208/230-1-60	208/230-1-60	208/230-1-60
Power Supply		Indoor unit powered from outdoor unit						
MCA	A.	0.3	0.2	0.2	0.22	0.25	0.5	0.5
Operating Range								
Cooling Indoor DB Min - Max	° F (° C)	62~90 (17~32)	62~90 (17~32)	62~90 (17~32)	62~90 (17~32)	62~90 (17~32)	62~90 (17~32)	62~90 (17~32)
Heating Indoor DB Min - Max	° F (° C)	32~86 (0~30)	32~86 (0~30)	32~86 (0~30)	32~86 (0~30)	32~86 (0~30)	32~86 (0~30)	32~86 (0~30)
Piping								
Pipe Connection Size - Liquid	in (mm)	1/4 (6.35)	1/4 (6.35)	1/4 (6.35)	1/4 (6.35)	3/8 (9.52)	3/8 (9.52)	3/8 (9.52)
Pipe Connection Size - Suction	in (mm)	1/2 (12.7)	3/8 (9.52)	1/2 (12.7)	1/2 (12.7)	5/8 (16)	5/8 (16)	5/8 (16)
Indoor								
Unit Width	in (mm)	31.89 (810)	31.89 (810)	31.89 (810)	42.91 (1090)	42.91 (1090)	53.15 (1350)	53.15 (1350)
Unit Height	in (mm)	11.81 (300)	11.81 (300)	11.81 (300)	13.31 (338)	13.31 (338)	14.37 (365)	14.37 (365)
Unit Depth	in (mm)	7.87 (200)	7.87 (200)	7.87 (200)	9.25 (235)	9.25 (235)	10.71 (272)	10.71 (272)
Net Weight	lbs (kg)	18.7 (8.5)	18.3 (8.3)	18.3 (8.3)	29.8 (13.5)	29.8 (13.5)	46.3 (21)	46.3 (21)
Number of Fan Speeds		4	4	4	4	4	4	4
Airflow (lowest to highest)	CFM	159/254/295/324	159/254/295/324	147/235/294/324	353/500/618/647	324/471/618/647	441/618/882/912	441/618/882/912
Sound Pressure (lowest to highest)	dB(A)	25.3/32.6/39.1	24.7/32.1/39.8	26.1/33/41	33.9/41.7/47	34.8/42.9/49.1	33/44/51	33/44/51
Air Throw Data	ft (m)	22.93 (6.99)	21.75 (6.63)	22.93 (6.99)	24.93 (7.6)	28.54 (8.7)	49.2 (15)	49.2 (15)
Moisture Removal	Pint/h (L/h)	3.3 (1.56)	1.5 (0.7)	3.2 (1.51)	2.9 (1.38)	5.6 (2.67)	6.5 (3.09)	8.8 (4.17)
Field Drain Pipe Size O.D.	in (mm)	0.625 (16)	0.625 (16)	0.625 (16)	0.625 (16)	0.625 (16)	0.625 (16)	0.625 (16)

COMPATIBILITY:

Indoor Unit	DLF SHAH12XAJ	DLF SHAH09XAK	DLF SHAH12XAK	DLF SHAH18XAK	DLF SHAH24XAK	DLF SHAH30XAK	DLF SHAH36XAK
Outdoor Unit Single Zone*	DLCSRAH12AAJ	DLCSRAH09AAK	DLCSRAH12AAK	DLCSRAH18AAK	DLCSRAH24AAK	DLCSRAH30AAK	DLCSRAH36AAK
Outdoor Unit Multi-Zone*		DLCMRAH18BAK					
		DLCMRAH27CAK					
		DLCMRAH36DAK					
		DLCMRAH48EAK					

*Performance may vary based on the compatible outdoor units. See respective pages for performance data.



Maximum Flexibility for Optimal Comfort Control

INDOOR FEATURES

- Available in 208/230V
- Up to 22.5 SEER and 12.0 HSPF when paired with DLCSRA outdoor unit
- Modes: Cool, Heat, Dry, Fan, Auto
- Auto-restart function
- Louver control (fixed or swing)
- Three fan speeds
- Outside air intake
- Built-in condensate lift pump
- Follow Me (senses temperature at handheld remote)
- Heating Setback (46° F Heating Mode)
- Quiet indoor operation, as low as 27 dB(A)
- Aluminum Golden Hydrophilic pre-coated fins
- Grille/ceiling panel 2' x 2' sizes 09 to 18 KSALG0101AAA
- Grille/ceiling panel 3' x 3' size 24 P/N KSALG0201AAA

COMPATIBLE WITH:

- DLCSRA Outdoor Unit Single Zone (p 21)
- DLCMRA Outdoor Unit Multi-Zone (p 47)

Sizes: 09 / 12 / 18 / 24

Select sizes are ENERGY STAR® certified based on outdoor unit pairing



KEY FEATURES

Built-In Condensate Lift Pump

The Cassette is supplied with a condensate lift pump that is capable of lifting the water 29.5 in. (750 mm.) above the top of the unit.

Integrated Electrical Components

Easy maintenance with the circuit box inside the unit, provides a more compact size for easier installation.

CONTROLS

Wireless Remote Controller included with indoor unit

Optional Wired Remote Controller KSACN0101AAA (Timer Function)

Wired Remote Controller KSACN0501AAA (7-Day Programmable)



Wireless Remote Controller



Wired Controller (Timer Function) KSACN0101AAA



Wired Controller (7-Day Programmable) KSACN0501AAA

ACCESSORIES

Wi-Fi® Kit KSAIF0401AAA



24V Interface for third-party thermostat compatibility KSAIC0401230

NOTE: Grille is required; sold separately.



SPECIFICATIONS:

DLFSCA Cassette					
Heat Pump					
System					
Size		9	12	18	24
Indoor Model		DLFSCAH09XAK	DLFSCAH12XAK	DLFSCAH18XAK	DLFSCAH24XAK
Electrical					
Voltage-Phase-Cycle	V-Ph-Hz	208/230-1-60	208/230-1-60	208/230-1-60	208/230-1-60
Power Supply		Indoor unit powered from outdoor unit			
MCA	A.	0.2	0.2	0.2	0.3
Operating Range					
Cooling Indoor DB Min - Max	° F (° C)	62~90 (17~32)	62~90 (17~32)	62~90 (17~32)	62~90 (17~32)
Heating Indoor DB Min - Max	° F (° C)	32~86 (0~30)	32~86 (0~30)	32~86 (0~30)	32~86 (0~30)
Piping					
Pipe Connection Size - Liquid	in (mm)	1/4 (6.35)	1/4 (6.35)	1/4 (6.35)	3/8 (9.52)
Pipe Connection Size - Suction	in (mm)	3/8 (9.52)	1/2 (12.7)	1/2 (12.7)	5/8 (16)
Indoor					
Body Unit Width	in (mm)	22.44 (570)	22.44 (570)	22.44 (570)	33.07 (840)
Body Unit Height	in (mm)	10.24 (260)	10.24 (260)	10.24 (260)	8.07 (205)
Body Unit Depth	in (mm)	22.44 (570)	22.44 (570)	22.44 (570)	33.07 (840)
Body Net Weight	lbs (kg)	35.27 (16)	35.27 (16)	39.68 (18)	46.3 (21)
Grille Unit Width	in (mm)	25.47 (647)	25.47 (647)	25.47 (647)	37.4 (950)
Grille Unit Height	in (mm)	1.97 (50)	1.97 (50)	1.97 (50)	2.17 (55)
Grille Unit Depth	in (mm)	25.47 (647)	25.47 (647)	25.47 (647)	37.4 (950)
Grille Net Weight	lbs (kg)	5.51 (2.5)	5.51 (2.5)	5.51 (2.5)	11.02 (5)
Number of Fan Speeds		3	3	3	3
Airflow (lowest to highest)	CFM	270/306/353	253/296/350	439/485/562	625/761/878
Sound Pressure (lowest to highest)	dB(A)	33/35/38	27/34/42	33/40/46.5	47/50/52
Air Throw Data	ft (m)	23 (7)	23 (7)	30 (9)	30 (9)
Moisture Removal	Pint/h (L/h)	1.58 (0.75)	2.88 (1.366)	4.26 (2.02)	5.22 (2.47)
Field Drain Pipe Size O.D.	in (mm)	1 (25.4)	1 (25.4)	1 (25.4)	1 (25.4)

COMPATIBILITY:

Indoor Unit	DLFSCAH09XAK	DLFSCAH12XAK	DLFSCAH18XAK	DLFSCAH24XAK
Outdoor Unit Single Zone*	DLCSTRAH09AAK	DLCSTRAH12AAK	DLCSTRAH18AAK	DLCSTRAH24AAK
Outdoor Unit Multi-Zone*	DLCMRAH18BAK			
	DLCMRAH27CAK			
	DLCMRAH36DAK			
	DLCMRAH48EAK			

*Performance may vary based on the compatible outdoor units. See respective pages for performance data.



Flexible Installation & Increased Air Circulation

INDOOR FEATURES

- Available in 208/230V
- Up to 22.5 SEER and up to 12.0 HSPF when paired with DLCSRA outdoor unit
- Modes: Cool, Heat, Dry, Fan, Auto
- Vertical or horizontal installation
- Up to 0.64 in WG
- Rear or bottom return
- Variable CFM Operation
- Built-in condensate lift pump
- Follow Me (senses temperature at handheld remote)
- Heating Setback (46° F Heating Mode)
- Quiet indoor operation, as low as 30 dB(A)
- Aluminum Golden Hydrophilic pre-coated fins

COMPATIBLE WITH:

- DLCSRA Outdoor Unit Single Zone (p 21)
- DLCMRA Outdoor Unit Multi-Zone (p 47)

Sizes: 09 / 12 / 18 / 24

Select sizes are ENERGY STAR® certified based on outdoor unit pairing



KEY FEATURES

Vertical or Horizontal Installation

Designed for maximum installation flexibility with the built-in secondary drain pan, which allows the unit to be mounted vertically for either a floor- or ceiling-concealed installation depending on existing conditions.

Built-In Condensate Lift Pump

Supplied with a condensate lift pump that is capable of lifting the water a maximum of 29.5 in. (750 mm.) above the top of the unit.

CONTROLS

Wireless Remote Controller included with indoor unit

Optional Wired Remote Controller KSACN0101AAA (Timer Function)

Wired Remote Controller KSACN0501AAA

(7-Day Programmable) included with indoor unit



Wireless Remote Controller



Wired Controller (Timer Function) KSACN0101AAA



Wired Controller (7-Day Programmable) KSACN0501AAA

ACCESSORIES

Wi-Fi® Kit KSAIF0401AAA



24V Interface for third-party thermostat compatibility KSAIC0401230



SPECIFICATIONS:

DLFSDA Ducted					
Heat Pump					
System					
Size		9	12	18	24
Indoor Model		DLFSDAH09XAK	DLFSDAH12XAK	DLFSDAH18XAK	DLFSDAH24XAK
Electrical					
Voltage-Phase-Cycle	V-Ph-Hz	208/230-1-60	208/230-1-60	208/230-1-60	208/230-1-60
Power Supply		Indoor unit powered from outdoor unit			
MCA	A.	1.11	1.11	1.2	1.2
Operating Range					
Cooling Indoor DB Min - Max	° F (° C)	62~90 (17~32)	62~90 (17~32)	62~90 (17~32)	62~90 (17~32)
Heating Indoor DB Min - Max	° F (° C)	32~86 (0~30)	32~86 (0~30)	32~86 (0~30)	32~86 (0~30)
Piping					
Pipe Connection Size - Liquid	in (mm)	1/4 (6.35)	1/4 (6.35)	1/4 (6.35)	3/8 (9.52)
Pipe Connection Size - Suction	in (mm)	3/8 (9.52)	1/2 (12.7)	1/2 (12.7)	5/8 (16)
Indoor					
Unit Width	in (mm)	27.56 (700)	27.56 (700)	34.65 (880)	43.31 (1100)
Unit Height	in (mm)	7.87 (200)	7.87 (200)	8.27 (210)	9.8 (249)
Unit Depth	in (mm)	19.92 (506)	19.92 (506)	26.54 (674)	30.47 (774)
Net Weight	lbs (kg)	43.56 (19.8)	43.56 (19.8)	54 (24.5)	86.86 (39.4)
Number of Fan Speeds		3	3	3	3
Airflow (lowest to highest)	CFM	147/211/264	176/282/353	300/400/480	440/700/780
Sound Pressure (lowest to highest)	dB(A)	30/34/38	35/37/39	35/37/39	35.5/40/44
Max. Static Pressure	in (WG)	0.20	0.20	0.40	0.64
Field Drain Pipe Size O.D.	in (mm)	1 (25.4)	1 (25.4)	1 (25.4)	1 (25.4)

COMPATIBILITY:

Indoor Unit	DLFSDAH09XAK	DLFSDAH12XAK	DLFSDAH18XAK	DLFSDAH24XAK
Outdoor Unit Single Zone*	DLCSRAH09AAK	DLCSRAH12AAK	DLCSRAH18AAK	DLCSRAH24AAK
Outdoor Unit Multi-Zone*	DLCMRAH18BAK			
	DLCMRAH27CAK			
	DLCMRAH36DAK			
	DLCMRAH48EAK			

*Performance may vary based on the compatible outdoor units. See respective pages for performance data.



A Single Console for Optimized Heating & Cooling

INDOOR FEATURES

- Available in 208/230V
- Up to 22.5 SEER and 12.0 HSPF when paired with DLCSRA outdoor unit
- Modes: Cool, Heat, Dry, Fan, Auto
- Auto-restart function
- Size 12 capable of being mounted on floor only
- Sizes 18-24 capable of being mounted on floor or ceiling
- Louver control (fixed or swing)
- Three fan speeds
- Air discharge from top and bottom (size 12 only)
- Follow Me (senses temperature at handheld remote)
- Heating Setback (46° F Heating Mode)
- Quiet indoor operation, as low as 34 dB(A)
- Aluminum Golden Hydrophilic pre-coated fins

COMPATIBLE WITH:

- DLCSRA Outdoor Unit Single Zone (p 21)
- DLCMRA Outdoor Unit Multi-Zone (p 47)

Sizes: 12 / 18 / 24

Select sizes are ENERGY STAR® certified based on outdoor unit pairing



KEY FEATURES

2-Way Optional Air Outlet

For up and down air-outlet or up air-outlet. Only on size 12.

Outside Air Intake

Outside air can be brought into the room through the connection available on the indoor unit, which helps meet the ventilation requirement. Only on sizes 18-24.

CONTROLS

Wireless Remote Controller included with indoor unit

Optional Wired Remote Controller KSACN0101AAA (Timer Function)

Optional Wired Remote Controller KSACN0401AAA (7-Day Programmable) size 12

Optional Wired Remote Controller KSACN0501AAA (7-Day Programmable) sizes 18 and 24



Wireless Remote Controller



Wired Controller (Timer Function) KSACN0101AAA



Wired Controller (7-Day Programmable) KSACN0401AAA

ACCESSORIES

Wi-Fi® Kit (sizes 18-24) KSAIF0401AAA*

24V Interface for third-party thermostat compatibility KSAIC0401230



*Not available for size 12.

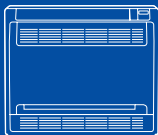

SPECIFICATIONS:

DLFSFA Console				
Heat Pump				
System				
Size		12	18	24
Indoor Model		DLFSFAH12XAK	DLFSFAH18XAK	DLFSFAH24XAK
Electrical				
Voltage-Phase-Cycle	V-Ph-Hz	208/230-1-60	208/230-1-60	208/230-1-60
Power Supply		Indoor unit powered from outdoor unit		
MCA	A.	0.3	1.0	1.0
Operating Range				
Cooling Indoor DB Min - Max	° F (° C)	62~90 (17~32)	62~90 (17~32)	62~90 (17~32)
Heating Indoor DB Min - Max	° F (° C)	32~86 (0~30)	32~86 (0~30)	32~86 (0~30)
Piping				
Pipe Connection Size - Liquid	in (mm)	1/4 (6.35)	1/4 (6.35)	3/8 (9.52)
Pipe Connection Size - Suction	in (mm)	1/2 (12.7)	1/2 (12.7)	5/8 (16)
Indoor				
Unit Width	in (mm)	27.56 (700)	42.05 (1068)	42.05 (1068)
Unit Height	in (mm)	23.62 (600)	26.57 (675)	26.57 (675)
Unit Depth	in (mm)	8.27 (210)	9.25 (235)	9.25 (235)
Net Weight	lbs (kg)	32.41 (14.7)	55.12 (25)	58.42 (26.5)
Number of Fan Speeds		3	3	3
Airflow (lowest to highest)	CFM	250/320/360	420/485/550	600/710/760
Sound Pressure (lowest to highest)	dB(A)	34/41/45	39/44/47	46/50/52
Air Throw Data	ft (m)	23 (7)	26 (8)	21.75 (6.63)
Field Drain Pipe Size O.D.	in (mm)	1 (25.4)	1 (25.4)	1 (25.4)

COMPATIBILITY:

Indoor Unit	DLFSFAH12XAK	DLFSFAH18XAK	DLFSFAH24XAK
Outdoor Unit Single Zone*	DLCSRAH12AAK	DLCSRAH18AAK	DLCSRAH24AAK
Outdoor Unit Multi-Zone*	DLCMRAH18BAK		
	DLCMRAH27CAK		
	DLCMRAH36DAK		
	DLCMRAH48EAK		

*Performance may vary based on the compatible outdoor units. See respective pages for performance data.

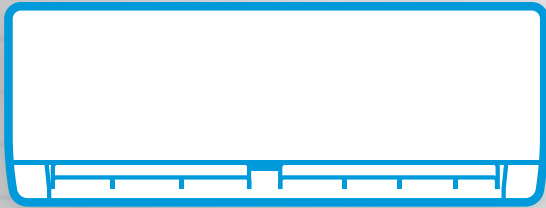





A Cost-Effective Outdoor Unit for **Economical Heating & Cooling**

OUTDOOR FEATURES

- Cost-competitive
- Available in 115V and 208/230V
- Built-in basepan heater on heat pump units
- Auto-restart function
- Condenser high-temperature protection
- Refrigerant leakage detection
- Quiet outdoor operation, as low as 52 dB(A)
- Aluminum Golden Hydrophilic pre-coated fins
- Piping length 82 - 164 ft. (25-50 m.)
- Cooling operating range 0° - 22° F (-17° - 50° C)
- Heating operating range 0° - 86° F (-17° - 30° C)

COMPATIBLE WITH:

- DLFEHAA High Wall Cooling Only (p 40)
- DLFEHAH High Wall Heat Pump (p 41)

Cooling Only - DLCERAA

Heat Pump with Basepan Heater - DLCERAH

Inverter Compressor

Up to 17.6 SEER

Up to 10.6 HSPF

Sizes: 09 / 12 / 18 / 24

KEY FEATURES

Cost-Effective

An economical choice that can provide comfort when you need it.

Rapid Cooling & Heating

After start-up, the compressor quickly gets up to maximum speed, cooling or heating the room in minutes.

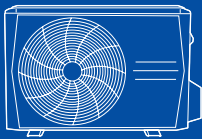

SPECIFICATIONS:

DLCERAH Outdoor Unit						
Heat Pump						
System						
Size		12	9	12	18	24
Outdoor Model		DLCERAH12AAJ	DLCERAH09AAK	DLCERAH12AAK	DLCERAH18AAK	DLCERAH24AAK
Electrical						
Voltage-Phase-Cycle	V-Ph-Hz	115-1-60	208/230-1-60	208/230-1-60	208/230-1-60	208/230-1-60
MCA	A.	13	8	10	15	18
MOCP - Fuse Rating	A.	20	15	15	20	25
Operating Range						
Cooling Outdoor DB Min - Max	° F (° C)	0~122 (-17~50)	0~122 (-17~50)	0~122 (-17~50)	0~122 (-17~50)	0~122 (-17~50)
Heating Outdoor DB Min - Max	° F (° C)	0~86 (-17~30)	0~86 (-17~30)	0~86 (-17~30)	0~86 (-17~30)	0~86 (-17~30)
Piping						
Total Piping Length	ft (m)	82 (25)	82 (25)	82 (25)	98 (30)	164 (50)
Piping Lift*	ft (m)	33 (10)	33 (10)	33 (10)	66 (20)	66 (20)
Pipe Connection Size - Liquid	in (mm)	1/4 (6.35)	1/4 (6.35)	1/4 (6.35)	1/4 (6.35)	3/8 (9.52)
Pipe Connection Size - Suction	in (mm)	1/2 (12.7)	3/8 (9.52)	1/2 (12.7)	1/2 (12.7)	5/8 (16)
Refrigerant						
Type		R410A	R410A	R410A	R410A	R410A
Charge	lbs (kg)	2.11 (0.96)	1.76 (0.80)	2.11 (0.96)	2.82 (1.28)	3.97 (1.80)
Outdoor						
Unit Width	in (mm)	30.31 (770)	30.31 (770)	30.31 (770)	31.50 (800)	33.27 (845)
Unit Height	in (mm)	21.85 (555)	21.85 (555)	21.85 (555)	21.81 (554)	27.64 (702)
Unit Depth	in (mm)	11.81 (300)	11.81 (300)	11.81 (300)	13.11 (333)	14.29 (363)
Net Weight	lbs (kg)	69 (31.3)	63 (28.6)	65.5 (29.7)	79.6 (36.1)	114.2 (51.8)
Airflow	CFM	1,170	1,170	1,170	1,170	1,765
Sound Pressure	dB(A)	54.5	57.2	57.4	57.0	60.2

*Condensing unit above or below indoor unit.

COMPATIBILITY:

Indoor Unit		Outdoor Unit				
		DLCERAH12AAJ	DLCERAH09AAK	DLCERAH12AAK	DLCERAH18AAK	DLCERAH24AAK
DLFEHAH High Wall	DLFEHAH12XAJ	•				
	DLFEHAH09XAK		•			
	DLFEHAH12XAK			•		
	DLFEHAH18XAK				•	
	DLFEHAH24XAK					•

PERFORMANCE:

DLFEHAA High Wall						
Heat Pump						
Indoor Model		DLFEHAA12XAJ	DLFEHAA09XAK	DLFEHAA12XAK	DLFEHAA18XAK	DLFEHAA24XAK
ENERGY STAR®		NO	NO	NO	NO	NO
Cooling System Tons		1.0	0.8	1.0	1.5	2.0
Cooling Rated Capacity	Btu/h	12,000	9,000	12,000	18,000	24,000
Cooling Cap. Range Min - Max	Btu/h	3,700-13,000	3,400-10,500	3,700-13,000	5,500-19,000	8,987-26,585
SEER		17.3	17.6	17.5	17.5	16.9
EER		10.0	11.2	11.2	11.2	9.7
Heating Rated Capacity (47° F)	Btu/h	12,000	9,800	12,000	18,000	24,800
Heating Rated Capacity (17° F)	Btu/h	8,000	7,500	9,230	11,600	18,000
Heating Maximum Capacity (5° F)	Btu/h	9,000	6,070	8,880	10,150	16,760
Heating Cap. Range Min - Max	Btu/h	3,500-13,500	2,800-11,500	3,500-13,500	6,200-19,000	8,371-25,350
HSPF		10.6	10.0	9.6	10.6	9.6
COP (47° F)	W/W	2.93	3.27	3.22	3.26	3.13
COP (5° F)	W/W	1.60	1.60	1.60	1.50	1.40

PERFORMANCE:

DLFEHAA High Wall					
Cooling Only					
Indoor Model		DLFEHAA12XAJ	DLFEHAA12XAK	DLFEHAA18XAK	DLFEHAA24XAK
ENERGY STAR®		NO	NO	NO	NO
Cooling System Tons		1.0	1.0	1.5	2.0
Cooling Rated Capacity	Btu/h	12,000	12,000	18,000	24,000
Cooling Cap. Range Min - Max	Btu/h	4,800~13,200	4,800~13,000	5,800~18,600	9,400~25,200
SEER		16.8	16.0	16.5	17.0
EER		10.7	11.2	10.3	10.9

An economical choice that can **provide comfort when you need it.**

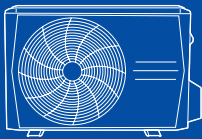

SPECIFICATIONS:

DLCERAA Outdoor Unit					
Cooling Only					
System					
Size		12	12	18	24
Outdoor Model		DLCERAA12AAJ	DLCERAA12AAK	DLCERAA18AAK	DLCERAA24AAK
Electrical					
Voltage-Phase-Cycle	V-Ph-Hz	115-1-60	208/230-1-60	208/230-1-60	208/230-1-60
MCA	A.	13	7	11	16
MOCP - Fuse Rating	A.	20	15	15	25
Operating Range					
Cooling Outdoor DB Min - Max	° F (° C)	0~122 (-17~50)	0~122 (-17~50)	0~122 (-17~50)	0~122 (-17~50)
Piping					
Total Piping Length	ft (m)	82 (25)	82 (25)	98 (30)	164 (50)
Piping Lift*	ft (m)	33 (10)	33 (10)	66 (20)	66 (20)
Pipe Connection Size - Liquid	in (mm)	1/4 (6.35)	1/4 (6.35)	1/4 (6.35)	3/8 (9.52)
Pipe Connection Size - Suction	in (mm)	1/2 (12.7)	1/2 (12.7)	1/2 (12.7)	5/8 (16)
Refrigerant					
Type		R410A	R410A	R410A	R410A
Charge	lbs (kg)	1.30 (0.59)	1.30 (0.59)	2.09 (0.95)	2.64 (1.20)
Outdoor					
Unit Width	in (mm)	30.31 (770)	30.31 (770)	31.50 (800)	33.27 (845)
Unit Height	in (mm)	21.85 (555)	21.85 (555)	21.81 (554)	27.64 (702)
Unit Depth	in (mm)	11.81 (300)	11.81 (300)	13.11 (333)	14.29 (363)
Net Weight	lbs (kg)	57.8 (26.2)	53.8 (24.4)	70.1 (31.8)	88.6 (40.2)
Airflow	CFM	1,170	1,170	1,170	1,880
Sound Pressure	dB(A)	52.0	54.0	57.0	59.5

*Condensing unit above or below indoor unit.

COMPATIBILITY:

Indoor Unit		Outdoor Unit			
		DLCERAA12AAJ	DLCERAA12AAK	DLCERAA18AAK	DLCERAA24AAK
DLFEHAA High Wall	DLFEHAA12XAJ	•			
	DLFEHAA12XAK		•		
	DLFEHAA18XAK			•	
	DLFEHAA24XAK				•



Easy Installation for Maximum Convenience & Comfort

INDOOR FEATURES

- Available in 115V and 208/230V
- Up to 17.6 SEER and up to 10.6 HSPF when paired with DLCERA outdoor unit
- Modes: Cool, Heat, Dry, Fan, Auto
- Turbo Mode
- Up-down louver control (fixed or swing)
- Remove filter from the top
- Improved serviceability
- Four fan speeds
- Sleep Mode
- Follow Me (senses temperature at handheld remote)
- Heating Setback (46° F Heating Mode)
- Quiet indoor operation, as low as 29 dB(A)
- Aluminum Golden Hydrophilic pre-coated fins

COMPATIBLE WITH:

- DLCERA Outdoor Unit Single Zone (p 35)
- DLCMRA Outdoor Unit Multi-Zone (p 47)

Cooling Only - DLFEHAA

Heat Pump - DLFEHAH

Sizes: 09 / 12 / 18 / 24

KEY FEATURES

Improved Serviceability

Full access to the terminal connections and fan after lifting the front cover of the High Wall for easy installation and service.

Convenient Filter Removal

The filter is located on the inlet, allowing for direct removal from the top of the unit without opening the cover.

CONTROLS

Wireless Remote Controller included with indoor unit
Optional Wired Remote Controller KSACN0401AAA (7-Day Programmable)



Wireless
Remote Controller



Wired Controller
(7-Day Programmable)
KSACN0401AAA

ACCESSORIES

Wi-Fi® High Wall Entry Tier 9/12/24 KSAIF0101AAA
Wi-Fi® High Wall Entry Tier 18k Only KSAIF0201AAA
24V Interface for third-party thermostat compatibility KSAIC0401230





SPECIFICATIONS:

DLFEHAA High Wall					
Cooling Only System					
Size		12	12	18	24
Indoor Model		DLFEHAA12XAJ	DLFEHAA12XAK	DLFEHAA18XAK	DLFEHAA24XAK
Electrical					
Voltage-Phase-Cycle	V-Ph-Hz	115-1-60	208/230-1-60	208/230-1-60	208/230-1-60
Power Supply		Indoor unit powered from outdoor unit			
MCA	A.	0.3	0.25	0.4	0.45
Controls					
Wireless Remote Controller (° F / ° C Convertible)		Standard	Standard	Standard	Standard
Wired Remote Controller (° F / ° C Convertible)		Optional	Optional	Optional	Optional
Operating					
Cooling Outdoor DB Min - Max	° F (° C)	63~90 (17~32)	63~90 (17~32)	63~90 (17~32)	63~90 (17~32)
Piping					
Pipe Connection Size - Liquid	in (mm)	1/4 (6.35)	1/4 (6.35)	1/4 (6.35)	3/8 (9.52)
Pipe Connection Size - Suction	in (mm)	1/2 (12.7)	1/2 (12.7)	1/2 (12.7)	5/8 (16)
Indoor					
Unit Width	in (mm)	32.00 (813)	32.00 (813)	38.36 (974)	43.83 (1113)
Unit Height	in (mm)	11.81 (300)	11.81 (300)	12.8 (325)	13.41 (341)
Unit Depth	in (mm)	7.75 (197)	7.75 (197)	8.87 (225)	9.22 (234)
Net Weight	lbs (kg)	17.64 (8)	17.64 (8)	23.15 (10.5)	30.86 (14)
Number of Fan Speeds		4	4	4	4
Airflow (lowest to highest)	CFM	190/239/301/328	188/238/305	344/422/506/550	420/514/609/640
Sound Pressure (lowest to highest)	dB(A)	29/36/41/42	28/35/40/42	34/39/43/45	39/44/49/49
Air Throw Data	ft (m)	22 (6.7)	22 (6.7)	24 (7.3)	39.4 (12)
Moisture Removal	Pint/h (L/h)	3.17 (1.50)	3.09 (1.46)	4.61 (2.18)	6.38 (3.02)
Field Drain Pipe Size O.D.	in (mm)	0.625 (16)	0.625 (16)	0.625 (16)	0.625 (16)

*Compatibility tables on next page.

SPECIFICATIONS:

DLFEHAH High Wall						
Heat Pump						
System						
Size		12	9	12	18	24
Indoor Model		DLFEHAH12XAJ	DLFEHAH09XAK	DLFEHAH12XAK	DLFEHAH18XAK	DLFEHAH24XAK
Electrical						
Voltage-Phase-Cycle	V-Ph-Hz	115-1-60	208/230-1-60	208/230-1-60	208/230-1-60	208/230-1-60
Power Supply		Indoor unit powered from outdoor unit				
MCA	A.	0.3	0.25	0.25	0.28	0.45
Controls						
Wireless Remote Controller (° F / ° C Convertible)		Standard	Standard	Standard	Standard	Standard
Wired Remote Controller (° F / ° C Convertible)		Optional	Optional	Optional	Optional	Optional
Operating						
Cooling Indoor DB Min - Max	° F (° C)	63~90 (17~32)	63~90 (17~32)	63~90 (17~32)	63~90 (17~32)	63~90 (17~32)
Heating Indoor DB Min - Max	° F (° C)	32~86 (0~30)	32~86 (0~30)	32~86 (0~30)	32~86 (0~30)	32~86 (0~30)
Piping						
Pipe Connection Size - Liquid	in (mm)	1/4 (6.35)	1/4 (6.35)	1/4 (6.35)	1/4 (6.35)	3/8 (9.52)
Pipe Connection Size - Suction	in (mm)	1/2 (12.7)	3/8 (9.52)	1/2 (12.7)	1/2 (12.7)	5/8 (16)
Indoor						
Unit Width	in (mm)	32.00 (813)	28.53 (725)	32.00 (813)	38.36 (974)	43.83 (1113)
Unit Height	in (mm)	11.81 (300)	11.81 (300)	11.81 (300)	12.8 (325)	13.41 (341)
Unit Depth	in (mm)	7.75 (197)	7.75 (197)	7.75 (197)	8.87 (225)	9.22 (234)
Net Weight	lbs (kg)	22.49 (10.2)	21.16 (9.6)	22.49 (10.2)	31.97 (14.5)	40.12 (18.2)
Number of Fan Speeds		4	4	4	4	4
Airflow (lowest to highest)	CFM	200/265/306/ 329	165/229/271/ 324	212/282/324/ 353	353/412/529/ 559	353/483/589/ 647
Sound Pressure (lowest to highest)	dB(A)	29/38/42/42	31/36/40/42	34/39/41/43	34/39/44/46	38/42/48/49
Air Throw Data	ft (m)	22 (6.7)	20.3 (6.2)	22.6 (6.9)	25 (7.6)	37.7 (11.5)
Moisture Removal	Pint/h (L/h)	3.49 (1.65)	2.05 (0.97)	3.38 (1.6)	4.63 (2.19)	5.73 (2.71)
Field Drain Pipe Size O.D.	in (mm)	0.625 (16)	0.625 (16)	0.625 (16)	0.625 (16)	0.625 (16)

*Compatibility tables on next page.



COMPATIBILITY:

Cooling Only				
Indoor Unit	DLFEHAA12XAJ	DLFEHAA12XAK	DLFEHAA18XAK	DLFEHAA24XAK
Outdoor Unit Single Zone*	DLCERAA12AAJ	DLCERAA12AAK	DLCERAA18AAK	DLCERAA24AAK
Outdoor Unit Multi-Zone*				

*Performance may vary based on the compatible outdoor units. See respective pages for performance data.

COMPATIBILITY:

Heat Pump					
Indoor Unit	DLFEHAH12XAJ	DLFEHAH09XAK	DLFEHAH12XAK	DLFEHAH18XAK	DLFEHAH24XAK
Outdoor Unit Single Zone*	DLCERAH12AAJ	DLCERAH09AAK	DLCERAH12AAK	DLCERAH18AAK	DLCERAH24AAK
Outdoor Unit Multi-Zone*		DLCMRAH18BAK			
		DLCMRAH27CAK			
		DLCMRAH36DAK			
		DLCMRAH48EAK			

*Performance may vary based on the compatible outdoor units. See respective pages for performance data.

Better Installation, Service & Maintenance for a Better HVAC Experience

We take pride in providing easy-to-use ductless solutions that offer simplified and flexible installation and maintenance. Now, with an improved mounting frame, a more flexible unit design and better filter access, we've made the installation, service and maintenance of our entry tier indoor units easier than ever.



IMPROVED MOUNTING

- New hook design on the mounting frame allows for a two-inch shift to the left and right
- High Wall paper template helps with installation
- Kick-stands lift the frame to provide easier access to piping, drain connections and wiring



ENHANCED UNIT DESIGN

- Rotatable front panel for easier installation and maintenance
- Removable chassis for quicker cleaning and replacement of the fan motor
- With only four screws to remove, significantly reduce maintenance time



EASIER FILTER ACCESS

- Filter located on the inlet for removal from the top of the unit
- No need to forcibly open the front panel to remove, and potentially bend, the filter

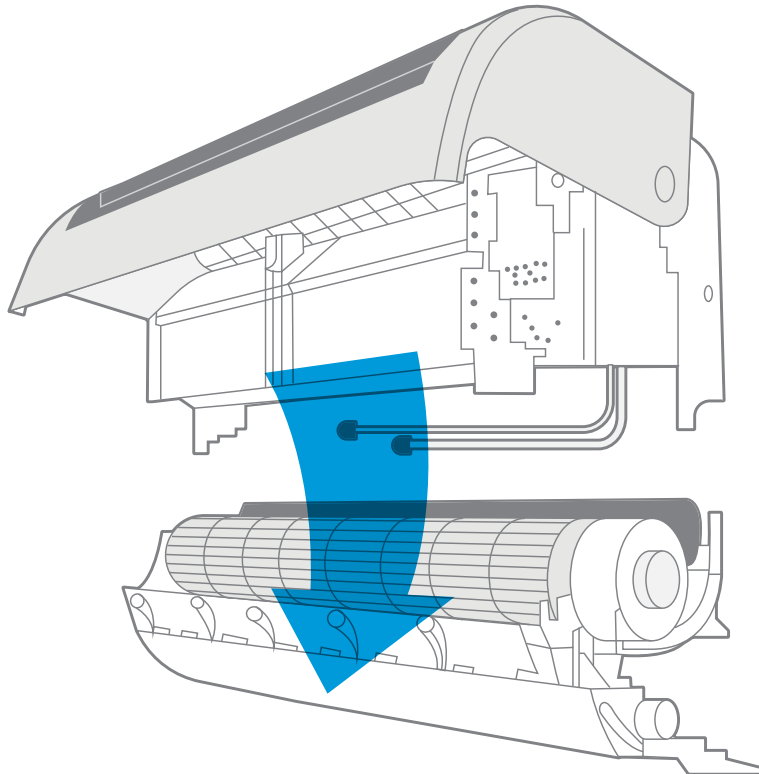
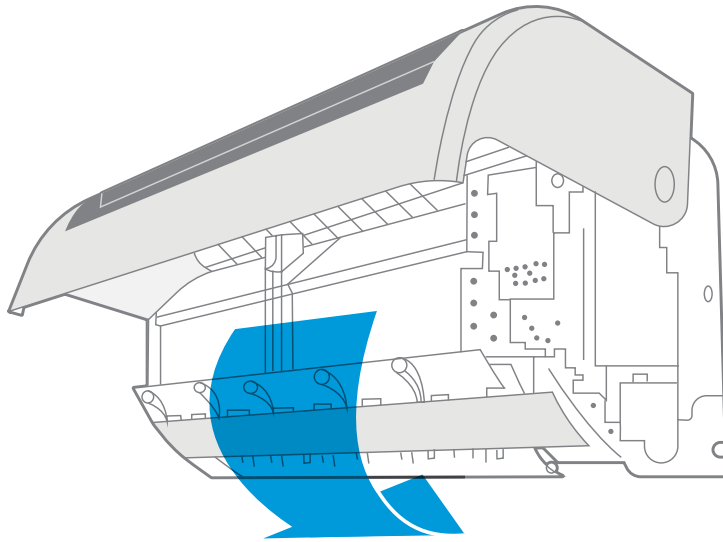
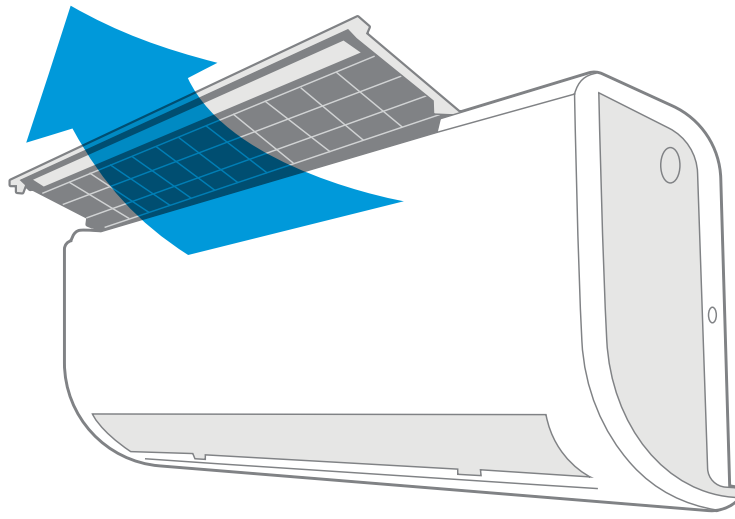

MULTI-ZONE



DLCMRA Outdoor Unit

Up to 21.4 SEER

Sizes: 18 / 27 / 36 / 48



A Multi-Zone Outdoor Unit for Flexibility & Control

OUTDOOR FEATURES

- Available in 208/230V
- Connect 2 - 5, multiple style indoor units
- Built-in basepan heater
- Quiet outdoor operation, as low as 62 dB(A)
- Aluminum Golden Hydrophilic pre-coated fins
- Total piping length 131-328 ft. (40 - 100 m.)
- Vertical lift/drop piping length 49 - 65 ft. (15 - 20 m.)
- Cooling operating range -13° - 122° F (-25° - 50° C)
- Heating operating range -22° - 86° F (-30° - 30° C)

COMPATIBLE WITH:

- DLFPHA High Wall (p 17)
- DLFSHA High Wall (p 25)
- DLFEHA High Wall (p 39)
- DLFSCA Cassette (p 27)
- DLFSDA Ducted (p 29)
- DLFSFA Console (p 31)

Heat Pump with Basepan Heater

Inverter Compressor

Up to 21.4 SEER

Up to 10.8 HSPF

Sizes: 18 / 27 / 36 / 48

Select systems are ENERGY STAR® certified based on indoor combinations



KEY FEATURES

Space Saving Installation

Up to five indoor units can be connected to a single outdoor unit, reducing the number of outdoor units required. All indoor units can be individually controlled and do not need to be installed at the same time.

Multiple Indoor Unit Styles

Flexibility on the options of indoor unit styles to fit any application or need.

Note: Multi-Zone units cannot heat and cool simultaneously.









SPECIFICATIONS:

DLCMRA Outdoor Unit					
Heat Pump					
Size		18	27	36	48
Outdoor Model		DLCMRAH18BAK	DLCMRAH27CAK	DLCMRAH36DAK	DLCMRAH48EAK
Max Number of Zones		2	3	4	5
Performance Non-Ducted					
ENERGY STAR®		YES	NO	NO	NO
Cooling System Tons		1.4	2.3	3.0	4.0
Cooling Rated Capacity	Btu/h	17,000	27,000	36,000	48,000
Cooling Cap. Range Min - Max	Btu/h	5,810-21,940	7,880-33,510	8,090-41,470	8,560-53,160
SEER		21.1	20.4	21.4	20.5
EER		12.5	11.5	10.5	11
Heating Rated Capacity (47° F)	Btu/h	18,000	27,000	36,000	48,000
Heating Maximum Capacity (5° F)	Btu/h	13,800	22,700	26,200	37,900
Heating Cap. Range Min - Max	Btu/h	5,760-24,480	6,010-36,180	6,350-41,950	7,210-55,820
HSPF		9.7	10.8	10.2	10.2
COP (47° F)	W/W	3.5	4.0	3.7	3.5
COP (5° F)	W/W	2.7	3.4	2.7	2.8
Performance Combination Ducted and Non-Ducted					
ENERGY STAR®		NO	NO	NO	NO
Cooling System Tons		1.5	2.3	3.0	4.0
Cooling Rated Capacity	Btu/h	17,500	27,000	36,000	48,000
Cooling Cap. Range Min - Max	Btu/h	5,795-20,708	7,765-31,955	8,060-39,990	8,510-52,580
SEER		19.8	19.5	19.7	19.1
EER		12.2	11.3	10.3	10.6
Heating Rated Capacity (47° F)	Btu/h	18,250	27,000	36,000	49,000
Heating Maximum Capacity (5° F)	Btu/h	14,100	21,850	27,300	37,350
Heating Cap. Range Min - Max	Btu/h	5,650-24,365	5,980-36,190	6,275-42,305	7,045-54,935
HSPF		9.6	9.9	10.0	10.2
COP (47° F)	W/W	3.7	3.8	3.5	3.5
COP (5° F)	W/W	2.4	3.0	2.6	2.3
Performance Ducted					
ENERGY STAR®		NO	NO	NO	NO
Cooling System Tons		1.5	2.3	3.0	4.0
Cooling Rated Capacity	Btu/h	18,000	27,000	36,000	48,000
Cooling Cap. Range Min - Max	Btu/h	5,780-19,476	7,650-30,400	8,030-38,510	8,460-52,000
SEER		18.4	18.5	17.9	17.6
EER		11.8	11.0	10.0	10.1
Heating Rated Capacity (47° F)	Btu/h	18,500	27,000	36,000	50,000
Heating Maximum Capacity (5° F)	Btu/h	14,400	21,000	28,400	36,800
Heating Cap. Range Min - Max	Btu/h	5,539-24,249	5,950-36,200	6,200-42,660	6,880-54,050
HSPF		9.4	9.0	9.7	10.1
COP (47° F)	W/W	3.8	3.5	3.2	3.4
COP (5° F)	W/W	2.1	2.7	2.5	1.8
Operating Range					
Cooling Outdoor DB Min - Max	° F (° C)	-13-122 (-25-50)	-13-122 (-25-50)	-13-122 (-25-50)	-13-122 (-25-50)
Heating Outdoor DB Min - Max	° F (° C)	-22-86 (-30-30)	-22-86 (-30-30)	-22-86 (-30-30)	-22-86 (-30-30)
Piping					
Total Piping Length	ft (m)	131 (40)	197 (60)	263 (80)	328 (100)
Piping to furthest FCU	ft (m)	82 (25)	98 (30)	115 (35)	115 (35)
Drop (OD above ID)	ft (m)	49 (15)	49 (15)	49 (15)	65 (20)
Lift (OD below ID)	ft (m)	49 (15)	49 (15)	49 (15)	65 (20)
Pipe Connection Size - Liquid	in (mm)	1/4*2 (6.35*2)	1/4*3 (6.35*3)	1/4*4 (6.35*4)	1/4*5 (6.35*5)
Pipe Connection Size - Suction	in (mm)	3/8*2 (9.52*2)	3/8*3 (9.52*3)	1/2 *1+ 3/8*3 (12.7*1+9.52*3)	1/2 *2+ 3/8*3 (12.7*2+9.52*3)

SPECIFICATIONS:

DLCMRA Outdoor Unit					
Heat Pump					
Outdoor Model		DLCMRAH18BAK	DLCMRAH27CAK	DLCMRAH36DAK	DLCMRAH48EAK
Refrigerant					
Type		R410A	R410A	R410A	R410A
Charge	lbs (kg)	4.41 (2.0)	6.17(2.8)	6.61 (3.0)	10.13 (4.6)
Electrical					
Voltage-Phase-Cycle	V-Ph-Hz	208/230-1-60	208/230-1-60	208/230-1-60	208/230-1-60
Power Supply		Indoor unit powered from outdoor unit			
MCA	A.	18	25	30	35
MOCP - Fuse Rating	A.	25	35	45	50
Outdoor					
Unit Width	in (mm)	37.31 (948)	41.22 (1047)	41.22 (1047)	41.15 (1045)
Unit Height	in (mm)	27.64 (702)	31.88 (810)	31.88 (810)	52.48 (1333)
Unit Depth	in (mm)	14.82 (376)	17.91 (455)	17.91 (455)	17.63 (448)
Net Weight	lbs (kg)	105.8 (48)	149.9 (68)	156.5 (71)	223.8 (101.5)
Airflow	CFM	1,390	2,130	2,130	4,500
Sound Pressure	dB(A)	62	63	62	64

COMPATIBILITY:

	Indoor Unit	Outdoor Unit				
		DLCMRAH18BAK	DLCMRAH27CAK	DLCMRAH36DAK	DLCMRAH48EAK	
DLFPHA High Wall	DLFPHA09XAK	•	•	•	•	
	DLFPHA12XAK	•	•	•	•	
	DLFPHA18XAK					
	DLFPHA24XAK					
DLFSHA High Wall	DLFSHA09XAK	•	•	•	•	
	DLFSHA12XAK	•	•	•	•	
	DLFSHA18XAK		•	•	•	
	DLFSHA24XAK			•	•	
DLFEHA High Wall	DLFEHA09XAK	•	•	•	•	
	DLFEHA12XAK	•	•	•	•	
	DLFEHA18XAK		•	•	•	
	DLFEHA24XAK			•	•	
DLFSCA Cassette	DLFSCA09XAK	•	•	•	•	
	DLFSCA12XAK	•	•	•	•	
	DLFSCA18XAK		•	•	•	
	DLFSCA24XAK			•	•	
DLFSDA Ducted	DLFSDA09XAK	•	•	•	•	
	DLFSDA12XAK	•	•	•	•	
	DLFSDA18XAK		•	•	•	
	DLFSDA24XAK			•	•	
DLFSFA Console	DLFSFA12XAK	•	•	•	•	
	DLFSFA18XAK		•	•	•	
	DLFSFA24XAK			•	•	

Manufacturer reserves the right to discontinue, or change at any time, specification or designs without notice or incurring obligations.



COMBINATION CHART:

DLCMRA Outdoor Unit				
Outdoor Model	2-Zone	3-Zone	4-Zone	5-Zone
DLCMRAH18BAK	9+9			
	9+12			
	12+12			
DLCMRAH27CAK	9+9	9+9+9		
	9+12	9+9+12		
	9+18	9+9+18		
	12+12	9+12+12		
	12+18	12+12+12		
	18+18			
DLCMRAH36DAK	9+9	9+9+9	9+9+9+9	
	9+12	9+9+12	9+9+9+12	
	9+18	9+9+18	9+9+9+18	
	9+24	9+9+24	9+9+12+12	
	12+12	9+12+12	9+9+12+18	
	12+18	9+12+18	9+12+12+12	
		9+12+24		
	12+24	9+18+18	12+12+12+12	
	18+18	12+12+12		
		12+12+18		
	12+18+18			
	12+12+24			
DLCMRAH48EAK	9+18	9+9+9	9+9+9+9	9+9+9+9+9
	9+24	9+9+12	9+9+9+12	9+9+9+9+12
	12+12	9+9+18	9+9+9+18	9+9+9+9+18
	12+18	9+9+24	9+9+9+24	9+9+9+9+24
	12+24	9+12+12	9+9+12+12	9+9+9+12+12
	18+18	9+12+18	9+9+12+18	9+9+9+12+18
	18+24	9+12+24	9+9+12+24	9+9+9+18+18
	24+24	9+18+18	9+9+18+18	9+9+12+12+12
		9+18+24	9+9+18+24	9+9+12+12+18
		9+24+24	9+12+12+12	9+12+12+12+12
		12+12+12	9+12+12+18	9+12+12+12+18
		12+12+18	9+12+12+24	12+12+12+12+12
		12+12+24	9+12+18+18	
		12+18+18	9+18+18+18	
		12+18+24	12+12+12+12	
		12+24+24	12+12+12+18	
	18+18+18	12+12+12+24		
	18+18+24	12+12+18+18		

Up to five indoor units can be connected to a single outdoor unit, reducing the number of outdoor units required.

SINGLE ZONE LIGHT COMMERCIAL

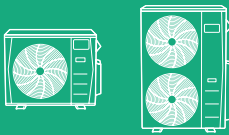

DLCLRA Outdoor Unit

Up to 18.0 SEER

Sizes: 36 / 48 / 58



DLFLCA Cassette

Sizes: 36 / 48



DLFLDA Ducted

Sizes: 36 / 48 / 58



DLFLFA Console

Sizes: 36 / 48 / 58

A Light Commercial Outdoor Unit for Improved Performance



OUTDOOR FEATURES

- Available in 208/230V
- Built-in basepan heater
- Condenser high-temperature protection
- Refrigerant leakage detection
- Quiet outdoor operation, as low as 62.5 dB(A)
- Aluminum Golden Hydrophilic pre-coated fins
- Piping length 213 ft. (65 m.)
- Cooling operating range -13° ~ 122° F (-25° ~ 50° C)
- Heating operating range -22° ~ 86° F (-30° ~ 30° C)

COMPATIBLE WITH:

- DLFLCA Cassette (p 57)
- DLFLDA Ducted (p 59)
- DLFLFA Console (p 61)

Heat Pump with Basepan Heater

Inverter Compressor

Up to 18.0 SEER

Up to 11.5 HSPF

Sizes: 36 / 48 / 58

KEY FEATURES

Longer Piping Lengths

Piping flexibility up to a total piping length of 213 ft. (65 m.).

Low Ambient Cooling Kit

With a built-in Low Ambient Cooling Kit or specially designed PCB, outdoor fan speeds can be changed automatically based on the temperature. The unit can run cooling operation even in low ambient temperatures.

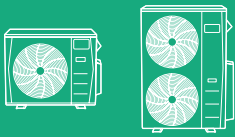

PERFORMANCE:

DLFLCA Cassette			
Indoor Model		DLFLCAH36XAK	DLFLCAH48XAK
ENERGY STAR®		NO	NO
Cooling System Tons		3.0	4.0
Cooling Rated Capacity	Btu/h	36,000	48,000
Cooling Cap. Range Min - Max	Btu/h	8,500~38,000	9,000~50,000
SEER		17.5	16.8
EER		9.0	9.5
Heating Rated Capacity (47° F)	Btu/h	38,000	50,000
Heating Rated Capacity (17° F)	Btu/h	25,200	35,000
Heating Maximum Capacity (5° F)	Btu/h	25,300	34,000
Heating Cap. Range Min - Max	Btu/h	9,500~50,000	10,000~55,000
HSPF		10.5	11.0
COP (47° F)	W/W	3	3.6
COP (17° F)	W/W	2.46	2.62
COP (5° F)	W/W	1.71	1.84

PERFORMANCE:

DLFLDA Ducted				
Indoor Model		DLFLDAH36XAK	DLFLDAH48XAK	DLFLDAH58XAK
ENERGY STAR®		NO	NO	NO
Cooling System Tons		3.0	4.0	4.8
Cooling Rated Capacity	Btu/h	36,000	48,000	57,000
Cooling Cap. Range Min - Max	Btu/h	8,500~38,000	9,000~50,000	18,000~58,000
SEER		16.5	17.4	18.0
EER		9	9.2	10.0
Heating Rated Capacity (47° F)	Btu/h	40,000	49,500	62,000
Heating Rated Capacity (17° F)	Btu/h	27,600	33,400	37,600
Heating Maximum Capacity (5° F)	Btu/h	25,300	34,000	35,000
Heating Cap. Range Min - Max	Btu/h	9,500~50,000	10,000~55,000	12,000~63,000
HSPF		11.5	10.3	9.0
COP (47° F)	W/W	3	3.6	3.6
COP (17° F)	W/W	2.46	2.62	2.62
COP (5° F)	W/W	1.71	1.84	1.91

PERFORMANCE:

		DLFLFA Console		
Indoor Model		DLFLFAH36XAK	DLFLFAH48XAK	DLFLFAH58XAK
ENERGY STAR®		NO	NO	NO
Cooling System Tons		3.0	4.0	4.5
Cooling Rated Capacity	Btu/h	36,000	48,000	54,000
Cooling Cap. Range Min - Max	Btu/h	8,500~38,000	9,000~50,000	18,000~58,000
SEER		16.0	17.8	18.0
EER		8.0	9.3	9.8
Heating Rated Capacity (47° F)	Btu/h	38,000	50,000	60,000
Heating Rated Capacity (17° F)	Btu/h	25,400	35,000	39,000
Heating Capacity (5° F)	Btu/h	25,300	34,000	35,000
Heating Cap. Range Min - Max	Btu/h	9,500~50,000	10,000~55,000	12,000~63,000
HSPF		10.0	11.0	10.5
COP (47° F)	W/W	3	3.6	3.6
COP (17° F)	W/W	2.46	2.62	2.62
COP (5° F)	W/W	1.71	1.84	1.91

COMPATIBILITY:

Indoor Unit		Outdoor Unit		
		DLCLRAH36AAK	DLCLRAH48AAK	DLCLRAH58AAK
DLFLCA Cassette	DLFLCAH36XAK	•		
	DLFLCAH48XAK		•	
DLFLAD Ducted	DLFLDAH36XAK	•		
	DLFLDAH48XAK		•	
	DLFLDAH58XAK			•
DLFLFA Console	DLFLFAH36XAK	•		
	DLFLFAH48XAK		•	
	DLFLFAH58XAK			•

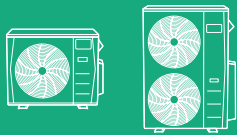

SPECIFICATIONS:

DLCLRA Outdoor Unit				
Heat Pump				
System				
Size		36	48	58
Outdoor Model		DLCLRAH36AAK	DLCLRAH48AAK	DLCLRAH58AAK
Electrical				
Voltage-Phase-Cycle	V-Ph-Hz	208/230-1-60	208/230-1-60	208/230-1-60
MCA	A.	30	35	35
MOCP - Fuse Rating	A.	50	50	50
Operating Range				
Cooling Outdoor DB Min - Max	° F (° C)	-13~122 (-25~50)	-13~122 (-25~50)	-13~122 (-25~50)
Heating Outdoor DB Min - Max	° F (° C)	-22~86 (-30~30)	-22~86 (-30~30)	-22~86 (-30~30)
Piping				
Total Piping Length	ft (m)	213 (65)	213 (65)	213 (65)
Piping Lift*	ft (m)	98 (30)	98 (30)	98 (30)
Pipe Connection Size - Liquid	in (mm)	3/8 (9.52)	3/8 (9.52)	3/8 (9.52)
Pipe Connection Size - Suction	in (mm)	5/8 (16)	5/8 (16)	3/4 (19)
Refrigerant				
Type		R410A	R410A	R410A
Charge	lbs (kg)	6.72 (3.05)	9.26 (4.2)	10.19 (4.62)
Outdoor				
Unit Width	in (mm)	37.24 (946)	37.48 (952)	37.48 (952)
Unit Height	in (mm)	31.89 (810)	52.48 (1333)	52.48 (1333)
Unit Depth	in (mm)	16.14 (410)	16.34 (415)	16.34 (415)
Net Weight	lbs (kg)	148.59 (67.4)	217.4 (98.6)	225.09 (102.1)
Airflow	CFM	2,130	4,500	4,415
Sound Pressure	dB(A)	63.0	62.5	64.0

*Condensing unit above or below indoor unit.



Optimal Air Distribution & Light Commercial Comfort Control

INDOOR FEATURES

- Available in 208/230V
- Up to 17.5 SEER and 11.0 HSPF when paired with DLCLRA outdoor unit
- Modes: Cool, Heat, Dry, Fan, Auto Auto-restart function
- Louver control (fixed or swing)
- Three fan speeds
- Outside air intake
- Built-in condensate lift pump
- Follow Me (senses temperature at handheld remote)
- Heating Setback (46° F Heating Mode)
- Quiet indoor operation, as low as 49 dB(A)
- Aluminum Golden Hydrophilic pre-coated fins
- Grille/ceiling panel 3' x 3' P/N KSALG0201AAA

COMPATIBLE WITH:

- DLCLRA Outdoor Unit Single Zone

(p 53)

Sizes: 36 / 48

KEY FEATURES

Built-In Condensate Lift Pump

The Cassette is supplied with a condensate lift pump that is capable of lifting the water 29.5 in. (750 mm.) above the top of the unit.

360° Air Flow Panel

With the 360° air flow panel, air is distributed to every corner of the room.

CONTROLS

Wireless Remote Controller included with indoor unit

Optional Wired Remote Controller KSACN0101AAA (Timer Function)

Optional Wired Remote Controller KSACN0501AAA (7-Day Programmable)



Wireless Remote Controller



Wired Controller (7-Day Programmable) KSACN0501AAA

ACCESSORIES

Wi-Fi® Kit KSAIF0401AAA



24V Interface for third-party thermostat compatibility KSAIC0401230

NOTE: Grille is required; sold separately.



SPECIFICATIONS:

DLFLCA Cassette			
Heat Pump			
System			
Size		36	48
Indoor Model		DLFLCAH36XAK	DLFLCAH48XAK
Electrical			
Voltage-Phase-Cycle	V-Ph-Hz	208/230-1-60	208/230-1-60
Power Supply		Indoor unit powered from outdoor unit	
MCA	A.	0.8	1.6
Operating Range			
Cooling Indoor DB Min - Max	° F (° C)	63~90 (17~32)	63~90 (17~32)
Heating Indoor DB Min - Max	° F (° C)	32~86 (0~30)	32~86 (0~30)
Piping			
Pipe Connection Size - Liquid	in (mm)	3/8 (9.52)	3/8 (9.52)
Pipe Connection Size - Suction	in (mm)	5/8 (16)	5/8 (16)
Indoor			
Body Unit Width	in (mm)	33.07 (840)	33.07 (840)
Body Unit Height	in (mm)	9.65 (245)	11.3 (287)
Body Unit Depth	in (mm)	33.07 (840)	33.07 (840)
Body Net Weight	lbs (kg)	58.2 (26.4)	63.27 (28.7)
Panel Unit Width		37.4 (950)	37.4 (950)
Panel Unit Height	in (mm)	2.17 (55)	2.17 (55)
Panel Unit Depth	in (mm)	37.4 (950)	37.4 (950)
Panel Net Weight	lbs (kg)	11.02 (5)	11.02 (5)
Number of Fan Speeds		3	3
Airflow (lowest to highest)	CFM	809/958/1095	853/1030/1177
Sound Pressure (lowest to highest)	dB(A)	49/52/55	49/52/55
Air Throw Data	ft (m)	30 (9)	30 (9)
Moisture Removal	Pint/h (L/h)	8.53 (4.04)	13.5 (6.39)
Field Drain Pipe Size O.D.	in (mm)	1 (25.4)	1 (25.4)

COMPATIBILITY:

Indoor Unit	DLFLCAH36XAK	DLFLCAH48XAK
Outdoor Unit Single Zone*	DLCLRAH36AAK	DLCLRAH48AAK

*Performance may vary based on the compatible outdoor units. See respective pages for performance data.



Maximum Flexibility & Light Commercial Performance

INDOOR FEATURES

- Available in 208/230V
- Up to 18.0 SEER and 11.5 HSPF when paired with DLCLRA outdoor unit
- Modes: Cool, Heat, Dry, Fan, Auto
- Vertical (sizes 36 & 48) or horizontal installation
- Up to 0.8 in WG
- Rear or bottom return (sizes 36 & 48)
- Constant CFM operation on sizes 36 & 48 only
- Built-in condensate lift pump
- Follow Me (senses temperature at handheld remote)
- Heating Setback (46° F Heating Mode)
- Quiet indoor operation, as low as 38.5 dB(A)
- Aluminum Golden Hydrophilic pre-coated fins

COMPATIBLE WITH:

- DLCLRA Outdoor Unit Single Zone (p 53)

Sizes: 36 / 48 / 58

KEY FEATURES

Vertical or Horizontal Installation

Designed for maximum installation flexibility with the built-in secondary drain pan, which allows the unit to be mounted vertically for either a floor- or ceiling-concealed installation depending on existing conditions for sizes 36 and 48 only.

Built-In Condensate Lift Pump

Supplied with a condensate lift pump that is capable of lifting the water 29.5 in. (750 mm.) above the top of the unit.

CONTROLS

Wireless Remote Controller included with indoor unit
 Wired Remote Controller (7-Day Programmable) included with indoor unit



Wireless Remote Controller



Wired Controller (7-Day Programmable) KSACN0501AAA

ACCESSORIES

Wi-Fi® Kit KSAIF0401AAA



24V Interface for third-party thermostat compatibility KSAIC0401230



SPECIFICATIONS:

DLFLDA Ducted				
Heat Pump				
System				
Size		36	48	58
Indoor Model		DLFLDAH36XAK	DLFLDAH48XAK	DLFLDAH58XAK
Electrical				
Voltage-Phase-Cycle	V-Ph-Hz	208/230-1-60	208/230-1-60	208/230-1-60
Power Supply	Indoor unit powered from outdoor unit			
MCA	A.	2.45	3.2	3.65
Operating Range				
Cooling Indoor DB Min - Max	° F (° C)	63~90 (17~32)	63~90 (17~32)	63~90 (17~32)
Heating Indoor DB Min - Max	° F (° C)	32~86 (0~30)	32~86 (0~30)	32~86 (0~30)
Piping				
Pipe Connection Size - Liquid	in (mm)	3/8 (9.52)	3/8 (9.52)	3/8 (9.52)
Pipe Connection Size - Suction	in (mm)	5/8 (16)	5/8 (16)	3/4 (19)
Indoor				
Unit Width	in (mm)	53.54 (1360)	47.24 (1200)	55.12 (1400)
Unit Height	in (mm)	9.8 (249)	11.81 (300)	17.32 (440)
Unit Depth	in (mm)	30.47 (774)	34.41 (874)	33.78 (858)
Net Weight	lbs (kg)	106.48 (48.3)	119.71 (54.3)	163 (74)
Number of Fan Speeds		3	3	3
Airflow (lowest to highest)	CFM	700/910/1080	720/1030/1230	1260/1710/2150
Sound Pressure (lowest to highest)	dB(A)	38.5/42/45.5	46/49.5/50.5	51/54/57
Max. Static Pressure	in (WG)	0.64	0.64	0.80
Field Drain Pipe Size O.D.	in (mm)	1 (25.4)	1 (25.4)	1 (25.4)

COMPATIBILITY:

Indoor Unit	DLFLDAH36XAK	DLFLDAH48XAK	DLFLDAH58XAK
Outdoor Unit Single Zone*	DLCLRAH36AAK	DLCLRAH48AAK	DLCLRAH58AAK

*Performance may vary based on the compatible outdoor units. See respective pages for performance data.



Easy Light Commercial Installation & Quiet Operation

INDOOR FEATURES

- Available in 208/230V
- Up to 18.0 SEER and 11.0 HSPF when paired with DLCLRA outdoor unit
- Modes: Cool, Heat, Dry, Fan, Auto
- Auto-restart function
- Can be mounted on floor or ceiling
- Louver control (fixed or swing)
- Three fan speeds
- Follow Me (senses temperature at handheld remote)
- Heating Setback (46° F Heating Mode)
- Quiet indoor operation, as low as 43 dB(A)
- Aluminum Golden Hydrophilic pre-coated fins

COMPATIBLE WITH:

- DLCLRA Outdoor Unit Single Zone (p 53)

Sizes: 36 / 48 / 58

KEY FEATURES

Outside Air Intake

Outside air can be brought into the room through the connection available on the indoor unit, which helps meet the ventilation air requirements.

Flexible Installation

Can be installed on the floor or ceiling depending on the application.

CONTROLS

Wireless Remote Controller included with indoor unit

Optional Wired Remote Controller KSACN0101AAA (Timer Function)

Optional Wired Remote Controller KSACN0501AAA (7-Day Programmable)



Wireless Remote Controller



Wired Controller (7-Day Programmable) KSACN0501AAA

ACCESSORIES

Wi-Fi® Kit KSAIF0401AAA



24V Interface for third-party thermostat compatibility KSAIC0401230



SPECIFICATIONS:

DLFLFA Console				
Heat Pump				
System				
Size		36	48	58
Indoor Model		DLFLFAH36XAK	DLFLFAH48XAK	DLFLFAH58XAK
Electrical				
Voltage-Phase-Cycle	V-Ph-Hz	208/230-1-60	208/230-1-60	208/230-1-60
Power Supply		Indoor unit powered from outdoor unit		
MCA	A.	1.23	0.85	1.48
Operating Range				
Cooling Indoor DB Min - Max	° F (° C)	63~90 (17~32)	63~90 (17~32)	63~90 (17~32)
Heating Indoor DB Min - Max	° F (° C)	32~86 (0~30)	32~86 (0~30)	32~86 (0~30)
Piping				
Pipe Connection Size - Liquid	in (mm)	3/8 (9.52)	3/8 (9.52)	3/8 (9.52)
Pipe Connection Size - Suction	in (mm)	5/8 (16)	5/8 (16)	5/8 (16)
Indoor				
Unit Width	in (mm)	50.59 (1285)	64.96 (1650)	64.96 (1650)
Unit Height	in (mm)	9.25 (235)	9.25 (235)	9.25 (235)
Unit Depth	in (mm)	26.57 (675)	26.57 (675)	26.57 (675)
Net Weight	lbs (kg)	69 (31.3)	83.78 (38)	110 (50)
Number of Fan Speeds		3	3	3
Airflow (lowest to highest)	CFM	638/917/1037	1000/1120/1350	796/1029/1385
Sound Pressure (lowest to highest)	dB(A)	43/49/54	52/54/57	46/49/55
Air Throw Data	ft (m)	33(10)	39(12)	39(12)
Field Drain Pipe Size O.D.	in (mm)	1 (25.4)	1 (25.4)	1 (25.4)

COMPATIBILITY:

Indoor Unit	DLFLFAH36XAK	DLFLFAH48XAK	DLFLFAH58XAK
Outdoor Unit Single Zone*	DLCLRAH36AAK	DLCLRAH48AAK	DLCLRAH58AAK

*Performance may vary based on the compatible outdoor units. See respective pages for performance data.

ACCESSORIES AND ADDITIONAL INFORMATION

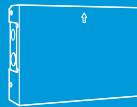

**24V Interface Kit
for Ductless Systems**



Wi-Fi® Kit



Improved Compatibility for Ductless Systems

FEATURES

- Control the ductless system using a third-party thermostat¹
- One 24V Interface Kit per indoor head²
- Keeps the Inverter compressor operating as a variable-speed system³
- Rated for outdoor and indoor mounting
- Dry mode contact for active dehumidification control
- Remote on/off contact
- Auxiliary heat control through the thermostat⁴
- Diagnostic code display LEDs
- Power supplied through the outdoor unit

COMPATIBLE WITH:

- DLFPHA High Wall (p 17)
- DLFSHA High Wall (p 25)
- DLFEHA High Wall (p 39)
- DLFSCA Cassette (p 27)
- DLFLCA Cassette (p 57)
- DLFSDA Ducted (p 29)
- DLFLDA Ducted (p 59)
- DLFSFA Console (p 31)
- DLFLFA Console (p 61)

KSAIC0401230

The Second Generation 24V Interface Kit allows both single **and** multi-zone ductless systems to be compatible with and controlled by any third-party, single-stage conventional thermostat.¹ The 24V Interface Kit maintains the benefits of variable-speed technology, enabling increased efficiency and comfort for end users.³

KEY BENEFITS

Maintain Inverter Compressor Technology

The new 24V Interface keeps the Inverter compressor operating as a variable-speed system when using a third-party thermostat, making adjustments to maintain more consistent operation.

Easy & Flexible Installation

Experience quick and easy installation between either a single or multi-zone outdoor unit and the fan coil. The interface can be installed either indoors or outdoors.

Consumer Choice & Control

Consumers can choose to use either the included Remote Controller or their preferred third-party thermostat to control each ductless unit.

ACCESSORIES

115V Transformer RCD#11203103000393 (Used only on ductless systems with 115V power.)

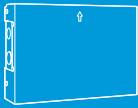

COMPATIBILITY:

The Second Generation of the 24V Interface Kit model number KSAIC0401230 is compatible with the ductless systems listed below. Before installation, check the compatibility of your ductless system. Product must be installed by a licensed HVAC technician.

Type of Indoor Unit	Indoor Family Name	Single Zone Outdoor Family Name	Multi-zone Outdoor Family Name	208/230V
High Wall	DLFPHA	DLCPRA	DLCMRA	All Sizes
	DFLSHA	DLCSRA	DLCMRA	All Sizes (see Note)
	DLFEHA	DLCERA	DLCMRA	All Sizes
Cassette	DLFSCA	DLCSRA	DLMRA	All Sizes
	DLFLCA	DLCLRA		All Sizes
Ducted	DLFSDA	DLCSRA	DLCMRA	All Sizes
	DLFLDA	DLCLRA		All Sizes Except Size 58 (See Note)
Console	DLFSFA	DLCSRA	DLCMRA	All Sizes Except Sizes 12 (See Note)
	DLFLFA	DLCLRA		All Sizes Except Size 58 (See Note)

Note: The Indoor unit requires an updated control board for compatibility with the 24V Interface Kit. High Wall units starting with Serial # V184810001 produced after Year 2018 Week 48 are shipped with the compatible control board. For other model numbers not shown on the table above, please contact your ductless representative. Ducted size 58 and Console sizes 12 and 58 starting with Serial # V191410001 are shipped with the compatible control board.

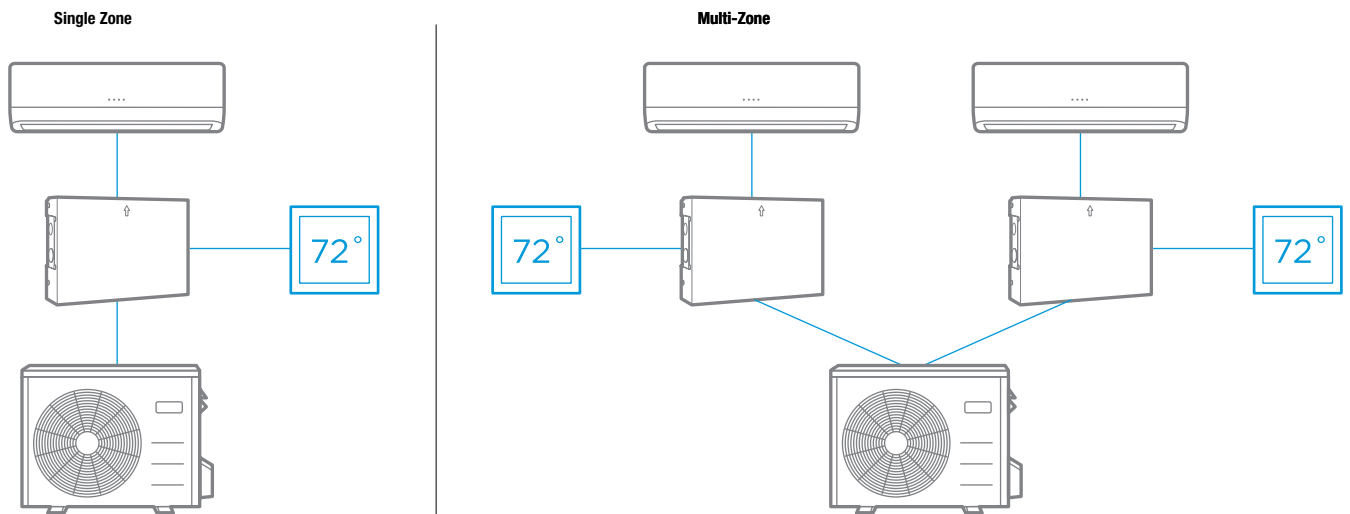

Notes:

¹Third-party thermostats used with the 24V Interface Kit will replace the wireless Remote Controller included with the unit. Consult with dealer for more information.

²When using in a Multi-zone System not all the indoor heads require a 24V Interface Kit.

³A conventional 5-wire thermostat is required.

⁴A secondary output is necessary for auxiliary heat control.

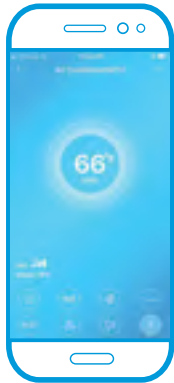

Get Climate Control at Your Fingertips with **Wi-Fi®** Connectivity

FEATURES

- Multiple modes, including Turbo, Cool, Heat, Dry, Fan, Auto and ECO (on compatible indoor units)
- Multiple fan speeds
- Sleep curve
- Up-down/right-left louver control (fixed or swing) on compatible indoor units
- Heating setback (46° F heating mode)
- Timer function for on/off scheduling

Midea ductless indoor units are Wi-Fi® enabled through our Wi-Fi® Accessory Kits. Easily connect to network apps from your hand-held device for system control on the go.

APPS

The Midea Air app is compatible with all kits and available in the App Store® for iOS devices and Google Play™ for Android devices.

COMPATABILITY

The Wi-Fi® Accessory Kits are backwards compatible with indoor units of the same series. No serial number cutout.

Wi-Fi® Accessories Model#	Description	DLFPHA	DLFSHA	DLFSCA DLFLCA	DLFSDA DLFLDA	DLFSFA DLFLFA	DLFEHA
KSAIF0101AAA	Wi-Fi® High Wall Entry Tier 9/12/24k						•
KSAIF0201AAA	Wi-Fi® High Wall Entry Tier - 18k ONLY						•
KSAIF0401AAA	Wi-Fi® Cassettes, Ducted, Console*			•	•	•	
KSAIF0501AAA	Wi-Fi® High Wall Mid-Tier		•				
KSAIF0601AAA	Wi-Fi® High Wall High Tier	•					

*Not available for Console size 12

Note: The Follow Me function is not selectable from the app, only available on the Wired or Wireless Remote Controllers (sensing temperature from the controller). If this mode is previously activated with the controller, the Follow Me functions would be deactivated if the Operation Mode is adjusted or if the unit is turned through the app.

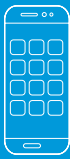

COMPONENTS:

All the components required for retrofit and operation are included with the Kits:

Kit Part Number	Indoor Unit Type	Components Included with Kit			
		Wi-Fi® USB Dongle	Wi-Fi® Translator PCB	USB Intermediate Cable	Display Box
KSAIF0101AAA	High Wall Entry Tier 9/12/24k	•		•	•
KSAIF0201AAA	High Wall Entry Tier 18k	•		•	•
KSAIF0401AAA	Cassette (all sizes) Ducted (all sizes) Console (only sizes 18-58)*	•	• Includes 19ft (6m) cable and Wireless Control		
KSAIF0501AAA	High Wall Mid-Tier (all sizes)	•		•	•
KSAIF0601AAA	High Wall High Tier (all sizes)	•			

The individual components included with the kits are also available through RCD for replacement.

*Not available for Console size 09 or 12

COMPATIBILITY:

The use of the Wi-Fi® Accessory Kits on some indoor units would disable the ability to use the Wired Controllers in some instances:

	Wired Control	Wireless Control
High Tier High Wall	•	•
Mid-Tier High Wall		•
Entry Tier High Wall		•
Ducted	•	•
Cassette	•	•
Console 18-58	•	•

Note: The use of the 24V interface will disable system's Wi-Fi® module. Please consider using a Wi-Fi® Thermostat when using the 24V interface.

Wi-Fi® kits cannot be used on networks requiring a user login.

Wi-Fi® kits are only supported with networks using WPA-PSK/WPA2-PSK encryption and no encryption. WPA-PSK/WPA2-PSK encryption is recommended.

Please consult the installation instructions and Owners Manuals of the individual kits for more information.

At Midea, we know that you work hard to uphold your reputation as a trusted dealer and expert in your market. And that you must consistently offer innovative, efficient, high-performing products and services to keep customers happy and stay competitive.

Essentially, we know what you need to be successful and we aim to create the best experience possible for you. That's why we provide all our dealers with top-notch factory support and team up with distributors to provide the tools needed for success, including:



Training on ductless systems



Dealer loyalty programs and incentives



A dealer locator tool to help drive leads



Educational and sales resources

It's all part of our commitment to helping you succeed and offer the greatest value and support to your customers.

NEED ASSISTANCE? WE'RE HERE FOR YOU!

Online: MideaDuctless.com

Phone: 800-381-9636



Get product information, find a dealer, download technical documents.



Get technical support and information regarding parts and service.

MODEL NUMBER NOMENCLATURE

Position	1	2	3	4	5	6	7	8	9	10	11	12
Description	Type Unit			Product Series	Unit Type	Major Series	Unit Type	Cooling Capacity 1,000 BTUh (nominal)	Max Number of Zones Connected to Outdoor Unit	Variations	Electrical Voltage-Phase	
Example	DLF = Fan Coil Indoor DLC = Condensing Unit Outdoor			P = Premium (High Tier) S = Standard (Mid-Tier) E = Entry Tier M = Multi-Zone L = Light Commercial	C = Cassette D = Ducted F = Console H = High Wall R = Outdoor	A = Standard	A = Air Conditioner (Cooling Only) H = Heat Pump	09 12 18 24 30 36 48 58	A = 1 B = 2 C = 3 D = 4 E = 5 X = Indoor Unit	A = Standard	J = 115-1 K=208/230-1	
Product Example 1: DLFPHAH09XAK	DLF = Fan Coil Indoor			P = Premium (High Tier)	H = High Wall	A = Standard	H = Heat Pump	09	X = Indoor Unit	A = Standard	K=208/230-1	
Product Example 2: DLCMRAH48EAK	DLC = Condensing Unit Outdoor			M = Multi-Zone	R = Outdoor	A = Standard	H = Heat Pump	48	E = 5 Units	A = Standard	K=208/230-1	

TIERS

Product Tier	Series Name
High Tier	Max Series
Mid-Tier	Advantage Series
Entry Tier	Standard Series

WARRANTY

Application / Tier	Warranty
All Applications / High Tier and Mid-Tier	7 Compressor / 5 Parts
All Applications / Entry Tier	5 Compressor / 2 Parts

*No Registration required.

CONTROLS

		Wired Controller		
		KSACN0101AAA	KSACN0401AAA	KSACN0501AAA
Function	Timer Function	X		
	7-Day Programmable		X	X
High Wall	DLFPHA		o	
	DLFSHA	o		
	DLFEHA		o	
Cassette	DLFSCA	o		o
Cassette	DLFLCA	o		o
Ducted	DLFSDA	o		•
Ducted	DLFLDA	o		•
Console	DLFSFA	o	o Size 12	o Sizes 18-24
Console	DLFLFA	o		o



•	Standard
o	Optional



Standard Features Glossary

24-Hour Timer

Set the unit to start and stop automatically in a 24-hour period.

Air Flow Panel

360° air outlet creates a soft and gentle air flow, which circulates throughout the whole space and provides an even temperature distribution in the room.

Auto Defrosting

Prevents the evaporator from freezing and maintains dehumidifying effect in low temperature environments.

Auto Restart Function

If the unit shuts off unexpectedly due to a power outage, it will restart with the previous settings automatically when the power resumes.

Built-In Basepan Heater

A heating belt is fitted on the base plate of the outdoor unit to prevent water accumulation, which improves heat transfer efficiency.

Built-In Condensate Lift Pump

A powerful, built-in drain pump can lift the condensing water up to 29 inches.

Control Box Inside the Cassette

Easy maintenance with the box right inside the Cassette indoor unit. The integrated design provides a more compact size for easier installation.

Convenient Temperature Controls

An intuitive, easy-to-use remote control displays temperature and other functions on a bright, clear LCD screen.

Convertible Return Air Inlet

The air inlet can be installed either at the back or bottom of the Ducted unit, allowing for flexible installation to meet the need of each job.

Crankcase Heater

A heating belt is fitted on the compressor to prevent frosting water accumulation, which improves heat transfer efficiency.

Diamond Outdoor Unit Design

An innovative outdoor unit reduces noise level by more than 3 dB(A), with higher reliability, easier maintenance and improved performance.

Eco Mode

Provides the ultimate energy savings and a comfortable sleeping environment with an intelligent eight-hour night cycle program that saves up to 60% of energy.

Extra Low Temperature Heating

When it's cold outside, it's warm inside. High Tier and Mid-Tier Ductless Systems can be used as a primary heat source, with heat output down to -22° F.

Follow Me

A temperature sensor built-in the Remote Controller will sense its surrounding temperature. The unit will adjust the room temperature more accurately to give you comfort.

Golden Fin Coating

A coating on the condenser preventing build-up of mold and bacteria while improving heat transfer efficiency.

High Ambient Cooling

The indoor space can be cooled to a desired, comfortable indoor temperature, even when outside temperatures reach up to 122° F.

High Heating Operation

The High Tier and Mid-Tier systems can be a primary heat source, with high Heating down to -22° F, so when it's cold outside, it's warm inside.

Independent Vane Control

Air flow direction from individual outlets can be controlled separately to achieve the optimal air flow based on a room's configuration.

Inverter Technology

With the Inverter, the outdoor unit uses only the energy required to meet the desired temperature requirements of the indoor unit, thus lowering electric bills.

Louver Position Memory

A horizontal louver will automatically move to the same position that was set the last time the unit was on.

Low Ambient Cooling

Even when it's cold outside, but warm inside, the air conditioner will keep the area cool — perfect for serve rooms and commercial kitchens.

Refrigerant Leak Detection

The indoor unit shows error code "EC" and stops automatically when refrigerant leakage is detected. This protects the compressor from high temperature damage due to refrigerant leakage.

Single and Multi-Zone Compatible

A single zone outdoor unit can be paired with any indoor unit type. One multi-zone unit can be leveraged for up to five indoor units of any style.

Sleep Mode

This function enables the system to automatically increase cooling or decrease heating by around four degrees for the first two hours, then holds steady for the next five hours. After that, it will switch off. This function achieves both energy savings and comfort at night.

Stepless Frequency Adjustment

Precise control maintains a stable and constant room temperature while reducing the sound level and saving energy.

Two-Way Draining

Connections, piping and drainage can be installed from both the left and right on the High Wall.

Universal Matching

Get maximum flexibility with up to five different indoor units connected to one outdoor unit. Maintain a different temperature in each room for ultimate comfort, with the best indoor unit choice for each. Universal matching units are also available for single zone outdoor units. One outdoor unit can match any type of indoor unit.

Wired Remote Controller

Compared to an infrared remote controller, a Wired Controller can be fixed on the wall and makes air conditioner operation more convenient for larger setups or Ducted units.



MideaDuctless.com

CMNA

3300 Riverwood Parkway SE, Ste 900,
Atlanta, GA 30339

©2019 CMNA, LLC;

Midea is a registered trademark owned by Midea Group Co., Ltd.
Wi-Fi® is a registered trademark of Wi-Fi Alliance.
ENERGY STAR® is a registered trademark of the U.S. EPA.

Part No. 328-30-0499-02
07/2019

